

vEX IQ
ROBOTICS
COMPETITION
RAPID RELAY

2024 - 2025
Game Manual
Version 2.1

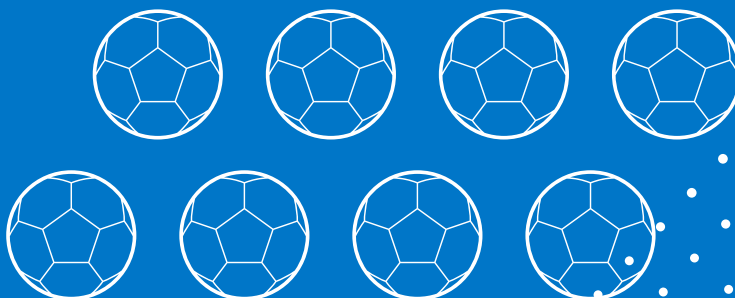

Table of Contents

Prefix

Changelog	iv
Quick Reference Guide	v

Section 1 - Introduction

About the Game Manual - A Note from the GDC	2
Updates	3
The Q&A System.....	4

Section 2 - The Game

Field Overview.....	5
General Definitions.....	6
Game-Specific Definitions	11
Scoring.....	15
Scoring Examples.....	19
Safety Rules	21
General Game Rules	22
Specific Game Rules.....	29

Section 3 - The Robot

Inspection Rules.....	34
-----------------------	----

Section 4 - The Event

Tournament Definitions	42
Tournament Rules.....	43

Section 5 - Robot Skills

Robot Skills Challenge Definitions	49
Robot Skills Challenge Rules	50

Appendix A - Field Overview

Appendix B - Student-Friendly Appendix

Field Overview.....	61
Versions of the Game.....	63
How to Earn Points	63
Important Scoring Rules	64
Rules	64

Prefix

Changelog

Version 2.1 - October 8, 2024

- Updated the "Field Overview" section of Section 2 to specify that using *Preloads* is required
- Added a new bullet to <SC3> to clarify that a *Ball* that passes through a *Target* and then returns onto the playing field does not count as a *Scored Ball*
- Revised the blue box of <SC4> to clarify intent
- Added a new bullet to <SC5> to clarify that each *Preload Ball* in a *Teamwork Match* can count for a maximum of one *Pass*
- Updated <G4c> to clarify intent of *Students* acting as *Loaders* for other *Teams*
- Updated <G9> to include <SG4>
- Updated <SG5d> to clarify that *Rapid Load Balls* may only be removed by *Robot* actions
- Updated <R7> to include #170 rubber bands
- Updated <RSC8> to clarify intent
- Minor typo / formatting fixes

Version 2.0 - September 3, 2024

- Added Appendix B, the Student-Friendly Appendix
- Added Significant Q&A grey boxes throughout the manual
- Added *Violation* notes and clarifications to <S1>, <S2>, <G1>, <G2>, <G4>, <R17>, and <T1> to clarify intent
- Updated the Blue Box in <SG6> to clarify referee procedure for removing *Balls* that are stuck inside the *Goal Wall*
- Minor typo / formatting fixes

Version 1.1 - August 6, 2024

- Added Grey Boxes throughout the manual to highlight significant Q&As pertaining to individual rules
- Updated <SG5> to clarify intent for *Loading Rapid Load Balls*
- Updated <SG6> to clarify that Referees can clear *Balls* from the *Goal Wall* after they've been *Scored*, but not before

Version 1.0 - June 25, 2024

- Rewrote the blue box in <SC4> to clarify intent
- Added a new bullet to <SG1> to state that *Robots* may not begin a *Match* in the same *Starting Zone* as an *Alliance* partner *Robot*
- Updated Figure SG-4 to clarify intent
- Updated <SG5d> to clarify that *Rapid Load Balls* may not contact the *Goal Wall* or the *Floor* outside of the *Starting Zone* before being retrieved by a *Robot* (i.e., bounced into *Targets*)
- Updated <R5d> to exclude non-functional decorations

- Minor typo / formatting fixes

Version 0.2 - June 4, 2024

- Added *Loader* as a new definition
- Updated <G5> to correct *Robot* size
- Updated <SG2> to clarify *Robot* expansion
- Updated the caption of Figure SG-4 to clarify intent
- Added two bullets to <R5> to clarify that using grease, oil, graphite, lubricants and tape is not legal
- Minor typo / formatting fixes

Version 0.1 - May 3, 2024

- Initial Release

Quick Reference Guide

Scoring Rules

<SC1>	All Scoring statuses are evaluated after the <i>Match</i> ends
<SC2>	All Scoring statuses are evaluated visually by a <i>Head Referee</i>
<SC3>	<i>Scored Goal</i> criteria
<SC4>	<i>Cleared Switch</i> criteria
<SC5>	<i>Pass</i> criteria
<SC6>	At the end of a <i>Match</i> , an <i>Alliance</i> cannot receive points for more <i>Passes</i> than <i>Goals</i>
<SC7>	Rapid Relay is designed to be scored in "real-time"

Safety Rules

<S1>	Stay safe, don't damage the <i>Field</i>
<S2>	<i>Students</i> must be accompanied by an <i>Adult</i>

General Game Rules

<G1>	Treat everyone with respect
<G2>	VIQRC is a <i>Student</i> -centered program
<G3>	Use common sense
<G4>	The <i>Robot</i> must represent the skill level of the <i>Team</i>
<G5>	<i>Robots</i> begin the <i>Match</i> in the starting size
<G6>	Keep your <i>Robot</i> together
<G7>	Don't damage the <i>Field</i>
<G8>	<i>Drivers</i> drive your <i>Robot</i> , and stay in the <i>Driver Station</i>
<G9>	Hands out of the <i>Field</i>
<G10>	Handling the <i>Robot</i> mid- <i>Match</i> is allowed under certain circumstances
<G11>	A <i>Team's</i> two <i>Drivers</i> switch controllers midway through the <i>Match</i>

Specific Game Rules

<SG1>	Pre- <i>Match</i> setup
<SG2>	<i>Robot</i> expansion is limited
<SG3>	Keep <i>Balls</i> in the <i>Field</i>
<SG4>	Using the <i>Loading Station</i>
<SG5>	Loading during the <i>Rapid Load Period</i>
<SG6>	Retrieving <i>Balls</i> from the <i>Pickup Zone</i>

Robot Rules	
<R1>	One <i>Robot</i> per <i>Team</i>
<R2>	<i>Robots</i> must represent the <i>Team's</i> skill level
<R3>	<i>Robots</i> must pass inspection
<R4>	Starting configuration
<R5>	Prohibited items
<R6>	VEX IQ product line
<R7>	Non-VEX IQ components
<R8>	Decorations are allowed
<R9>	Officially registered <i>Team</i> numbers must be displayed on <i>Robot License Plates</i>
<R10>	Let it go after the <i>Match</i> is over
<R11>	<i>Robot Brain</i>
<R12>	Motors
<R13>	Batteries
<R14>	Firmware
<R15>	Modification of Parts
<R16>	Pneumatics
<R17>	There is a difference between accidentally and willfully violating a <i>Robot</i> rule.

Tournament Rules	
<T1>	The <i>Head Referee</i> has final authority on all gameplay ruling decisions
<T2>	<i>Head Referees</i> must be qualified
<T3>	The <i>Drive Team Members</i> are permitted to immediately appeal the <i>Head Referee's</i> ruling
<T4>	The <i>Event Partner</i> has final authority regarding all non-gameplay decisions
<T5>	Be at your <i>Match</i> on time
<T6>	<i>Robots</i> at the field must be ready to play
<T7>	<i>Match</i> replays are allowed, but rare
<T8>	<i>Disqualifications</i>
<T9>	Timeouts
<T10>	Be prepared for minor field variance
<T11>	<i>Fields</i> and <i>Field Elements</i> may be repaired at the <i>Event Partner's</i> discretion
<T12>	<i>Teamwork Matches</i>
<T13>	Ending a <i>Match</i> early
<T14>	<i>Practice Matches</i> may be played at some events, but are not required
<T15>	<i>Qualification Matches</i> will occur according to the official <i>Match Schedule</i>
<T16>	Each <i>Team</i> will be scheduled <i>Qualification Matches</i> as follows
<T17>	<i>Teams</i> are ranked by their average <i>Qualification Match</i> scores
<T18>	<i>Teams</i> playing in <i>Finals Matches</i>
<T19>	<i>Finals Match Schedule</i>

Robot Skills Challenge Rules

<RSC1>	Standard rules apply in most cases
<RSC2>	Scoring <i>Robot Skills Matches</i>
<RSC3>	Robot Skills Field setup
<RSC4>	<i>Loading</i> differences
<RSC5>	Skills ranking at events
<RSC6>	Skills rankings globally
<RSC7>	Skills Match Schedule
<RSC8>	Handling <i>Robots</i> during an <i>Autonomous Coding Skills Match</i>
<RSC9>	Starting an <i>Autonomous Coding Skills Match</i>
<RSC10>	<i>Skills Stop Time</i>
<RSC11>	Robot Skills at League Events

Section 1

Introduction

Overview

This section provides an introduction to the VEX IQ Robotics Competition (VIQRC) and VIQRC Rapid Relay.

VEX IQ Robotics Competition Rapid Relay: A Primer

VEX IQ Robotics Competition Rapid Relay is played on a 6'x8' rectangular *Field*, set up as illustrated in the figures throughout this game manual.

The primary objectives of the game are to *Pass* the *Balls* between *Robots*, score *Balls* through *Targets*, and *Clear* *Switches*. *Balls* are introduced to the field through the *Loading Station* or, during the last 15 seconds of a *Match*, a Rapid Load Zone. Points are awarded based on how many *Goals* are *Scored*, how many *Switches* have been *Cleared*, and how many times the *Alliance* successfully *Passed* the *Ball* before scoring it.

In the *Teamwork Challenge*, an *Alliance* composed of two (2) *Robots* works together to score as many points as possible in a sixty (60) second *Match*.

Teams may also compete in *Robot Skills Matches*, where one (1) *Robot* tries to score as many points as possible with a slightly different set of rules. See Appendix B for more information.

Note: The illustrations in this section of the Game Manual are intended to provide a general visual understanding of the game. Teams should refer to official field specifications, found in Appendix A, for exact field dimensions, a full field bill of materials, and exact details of field construction.

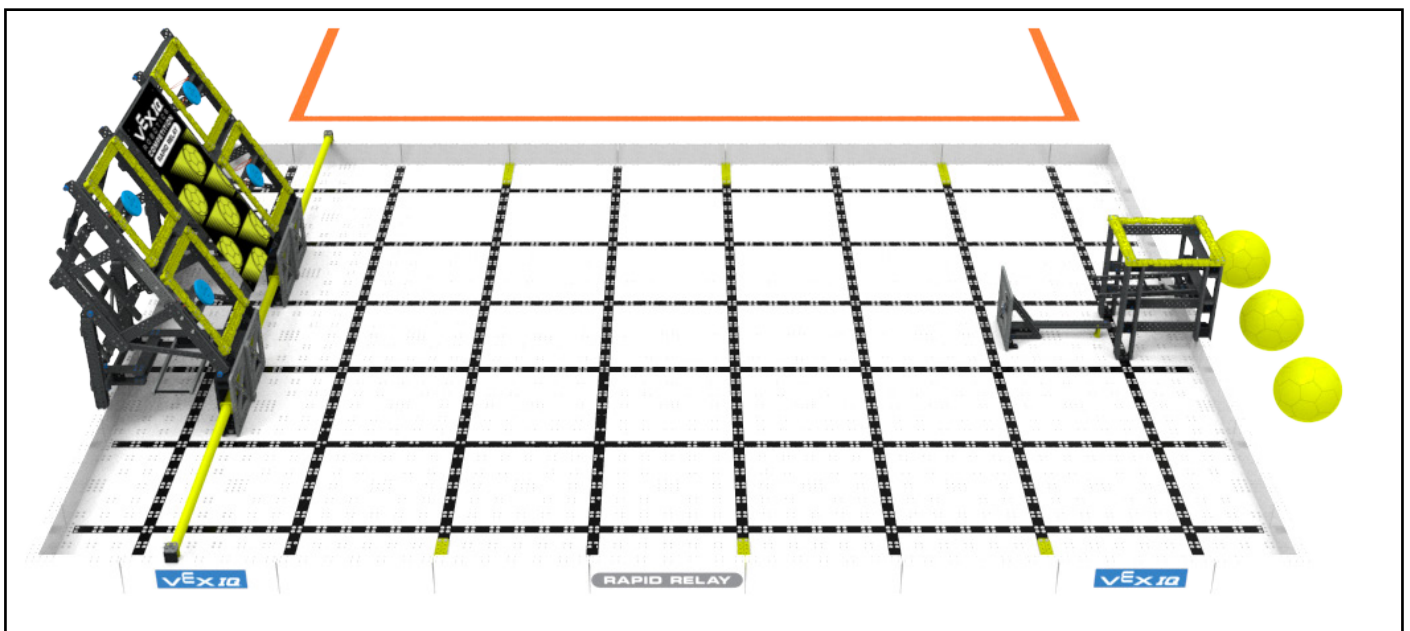

Figure O-1: Starting configuration of the Field for a VEX IQ Robotics Competition Rapid Relay Match.

About the Game Manual - A Note from the GDC

This Game Manual and its appendices contain everything there is to know about this season's game, VIQRC Rapid Relay. It is intended to be a resource for all *Teams*, *Head Referees*, *Event Partners*, and other members of the VIQRC community.

The rules contained in the following pages can be thought of as "constraints" that define this game, just as engineers begin any design project by defining their constraints. At the beginning of a season, "constraints" are all we have. We don't know what the winning *Robot*, best strategy, or most-frequently-violated rule will be any more than you do. Isn't that exciting?

When exploring a new game, please approach this Game Manual with that mentality of looking at rules as "constraints." The Game Manual and its appendices contain the full and complete list of constraints that are available for a competitor to strategize, design, and build their *Robots*.

Obviously, all *Teams* must adhere to these rules, and any stated intents of these rules. However, beyond that, there is no "right" way to play. There are no hidden restrictions, assumptions, or intended interpretations beyond what is written here. So, it is up to you, the competitor, to find the path through these constraints that best suits your *Team's* goals and ambitions.

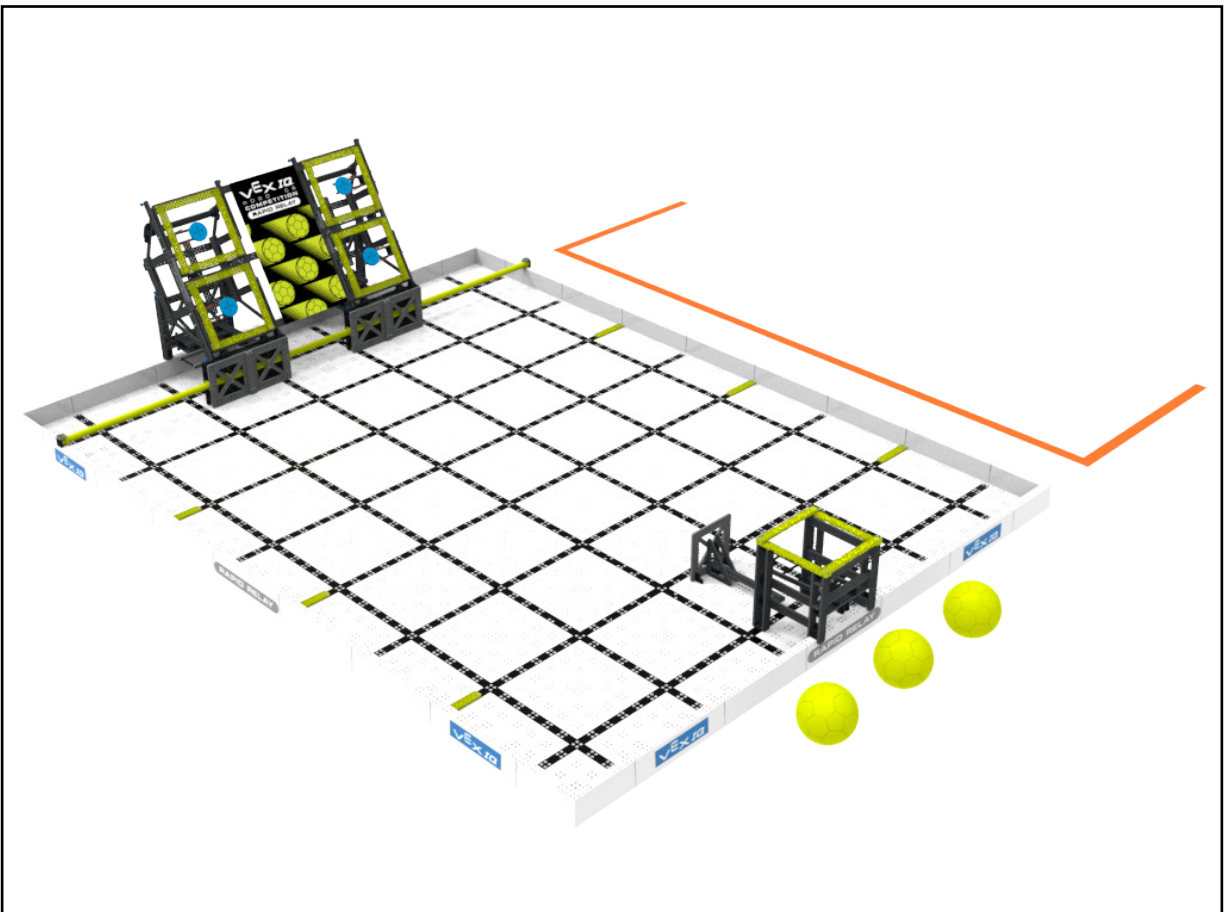

Figure O-2: Starting configuration of the Field for a VEX IQ Robotics Competition Rapid Relay Match.

Updates

This manual will have a series of “major” and “minor” updates over the course of the season. Each version is official and must be used in official VIQRC events until the release of the next version, upon which the previous version becomes void.

The latest version of the Game Manual can always be found at:
<https://link.vex.com/docs/24-25/viqrc-rapid-relay/GameManual>.

Known major release dates are as follows:

May 3, 2024	Version 0.1	Initial game release
May 14, 2024	N/A	Official Q&A system opens
June 4, 2024	Version 0.2	Minor typographical errors or formatting issues found in the initial release; very few rule changes are expected
June 25, 2024	Version 1.0	May include gameplay or rule changes inspired by input from the official Q&A system and the VEX community
August 6, 2024	Version 1.1	Clarification / minor update
Sept 3, 2024	Version 2.0	May include gameplay or rule changes inspired by early-season events
Oct 8, 2024	Version 2.1	Clarification / minor update
Dec 3, 2024	Version 2.2	Clarification / minor update
January 28, 2025	Version 3.0	May include gameplay or rule changes inspired by mid-season events
April 2, 2025	Version 4.0	May include gameplay or rule changes pertaining specifically to the VEX Robotics World Championship

In addition to these known major updates, there may also be unscheduled updates released throughout the season if deemed critical by the GDC. **Any unscheduled updates will always be released on a Tuesday, no later than 5:00 PM CST (11:00 PM GMT).** These updates will be announced via the VEX Forum, automatically pushed to the VIQRC Hub app, and shared via VEX Robotics / REC Foundation social media & email marketing channels.

Game Manual updates are effective immediately upon release; it is every *Team’s* responsibility to be familiar with all rules and updates. There are no “grace periods” if an update prohibits a previously legal part, mechanism, or strategy.

Note: REC Foundation Regional Support Managers will contact Event Partners involved with multi-week league events that “cross over” an unscheduled update. If a rule change impacts their event (such as a Robot which previously passed inspection no longer being legal), these cases will be reviewed individually depending on the context of the event and the rule that has changed. Exceptions may also be available for non-US championship events that occur within one (1) week of an update. These are the only possible “grace period” exceptions.

The Q&A System

When first reviewing a new robotics game, it is natural to have questions about situations which may not be immediately clear. Navigating the Game Manual and seeking out answers to these questions is an important part of learning a new game. In many cases, the answer may just be in a different place than you first thought—or, if there is no rule explicitly prohibiting a gameplay strategy, then that usually means it is legal!

However, if a *Team* is still unable to find an answer to their question after closely reviewing the relevant rules, then every *Team* has the opportunity to ask for official rules interpretations in the VEX Robotics Question & Answer System. These questions may be posted by an *Adult* via the RobotEvents account that is associated with that *Team*.

All responses in this Q&A system should be treated as official rulings from the VEX Robotics *Game Design Committee*, and they represent the correct and official interpretation of the VEX Robotics Competition Rules. The Q&A system is the only source besides the Game Manual for official rulings and clarifications, and is functionally an extension of the Game Manual. Like Game Manual updates, Q&A rulings are effective immediately upon release.

[The VEX IQ Robotics Competition Question & Answer System can be found here.](#)

Before posting on the Q&A system, be sure to review the [Q&A Usage Guidelines](#)

1. Read and search the manual before posting.
2. Read and search existing Q&As before posting.
3. Quote the applicable rule from the latest version of the manual in your question.
4. Make a separate post for each question.
5. Use specific and appropriate question titles.
6. Questions will (mostly) be answered in the order they were received.
7. This system is the only source for official rules clarifications.

If there are any conflicts between this Game Manual and other supplemental materials (e.g., Referee Certification courses, the VIQRC Hub app, the HTML version of the Game Manual, etc.), the most current version of the Game Manual takes precedence.

Similarly, it can never be assumed that definitions, rules, or other materials from previous seasons apply to the current game. Q&A responses from previous seasons are not considered official rulings for the current game. Any relevant clarifications that are needed should always be re-asked in the current season's Q&A.

Section 2

The Game

Field Overview

The VEX IQ Robotics Competition Rapid Relay field consists of the following:

- Three (3) *Balls*
 - Two (2), one per *Robot*, that are used as *Preloads*
 - One that begins outside the *Field*, to be used by a *Loader*
- One (1) *Goal Wall*
 - Four (4) *Targets*
 - Four (4) *Switches* that begin the *Match* "un-Cleared" (i.e., parallel with the *Goal Wall*)
- One (1) *Pickup Zone*
- One (1) *Loading Station*
- One (1) *Load Zone*
- Two (2) *Starting Zones*

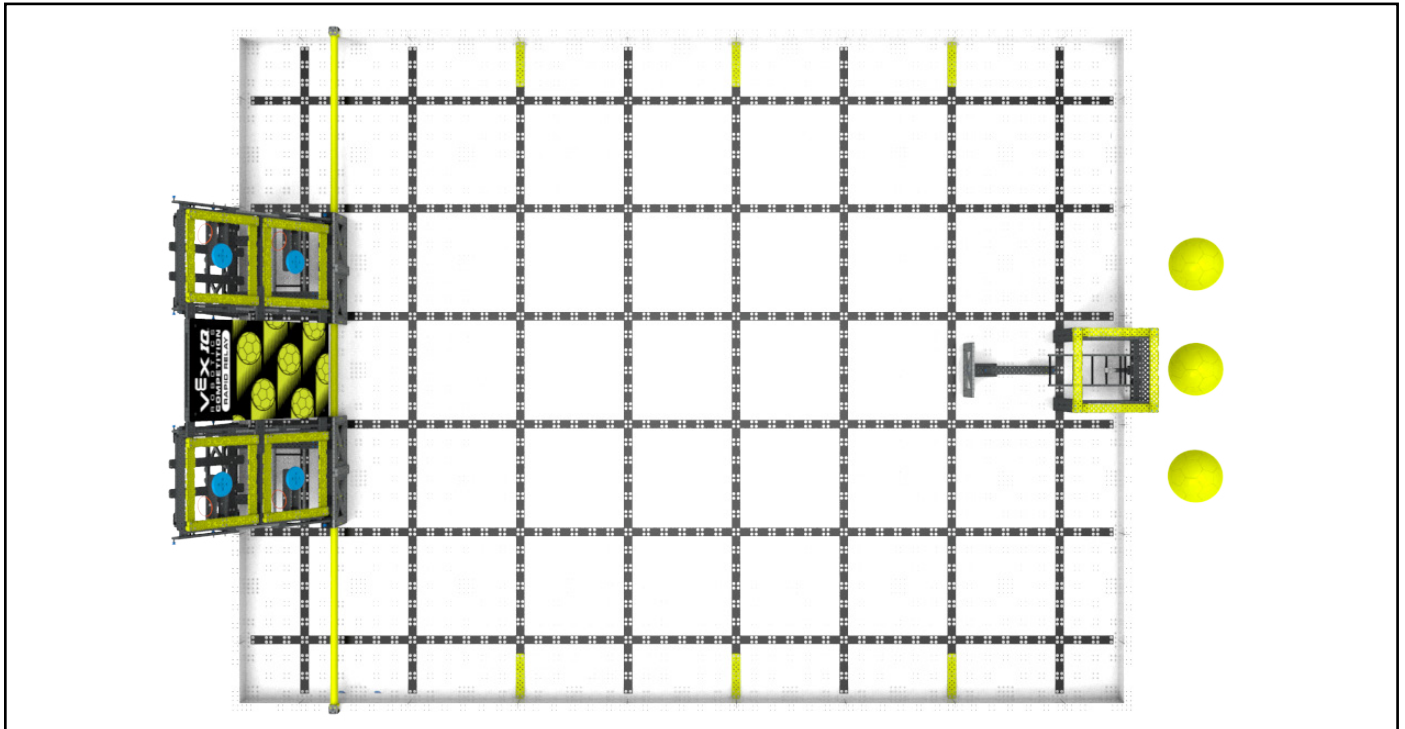

Figure FO-1: Starting configuration of the Field for a VEX IQ Robotics Competition Rapid Relay Match.

General Definitions

Adult – Anyone who is not a *Student* or another defined term (e.g., *Head Referee*).

Alliance – A pre-assigned grouping of two (2) *Teams* that are paired together during a given *Teamwork Challenge*.

Alliance Score – Points scored in a *Teamwork Challenge Match* that are awarded to both *Teams*.

Disablement – A penalty applied to a *Team* for a safety *Violation*. During *Disablement*, a *Team* is no longer allowed to operate their *Robot*, and the *Drivers* will be asked to place their *Controller* on the ground. A *Disablement* is not the same as a *Disqualification*.

Disqualification – A penalty applied to a *Team* for a rule violation (see <T8> for more details). If a *Team* receives a *Disqualification* in a *Match*, the *Head Referee* will notify the *Team* of their *Violation* at the end of the *Match*. At the *Head Referee*'s discretion, repeated *Violations* and/or *Disqualifications* for a single *Team* may lead to its *Disqualification* for the entire event.

Driver – A *Student Team* member who stands in the *Driver Station* and is responsible for operating and controlling that *Team's Robot*. Up to two *Team* members may fulfill this role in a given *Match* (see <G8>).

Driver Station – The region behind the *Field* where the *Drivers* must remain during their *Match* unless legally interacting with their *Robot*. The *Driver Station* is represented by the orange line in Figures O-1 and O-2.

Drive Team Members - The two *Drivers* and one *Loader* who participate in a given *Match* as representatives of their *Team*.

Field – The entire playing *Field*, being six (6) field tiles wide by eight (8) field tiles long (totaling forty-eight (48) field tiles), including the *Field Perimeter*.

Field Element – The *Field Perimeter*, *Floor*, PVC pipes, and VEX IQ elements which comprise and/or are attached to the *Field*.

Field Perimeter – The outer part of the *Field*, made up of four (4) outside corners and twenty-four (24) straight sections.

Floor – The interior flat part of the playing *Field*, made up of the forty-eight (48) field tiles that are within the *Field Perimeter*.

Game Design Committee (GDC) - The creators of VIQRC Rapid Relay, and authors of this Game Manual. The GDC is the only official source for rules clarifications and Q&A responses; see Section 1.

License Plate – A physical component on the *Robot* that displays the *Team's* VEX IQ Robotics Competition number. The *License Plate* must have a length and height of 3.5" x 1.5" (88.9mm x 38.1mm) and must not exceed a width of 0.25" (6.35mm) per <R9>.

Loader - The *Student(s)* on the *Team* who *Load Balls* into the *Field* during a *Match*. An *Adult* cannot be a *Loader* on a *Team*. *Loaders* cannot also be a *Driver* in the same *Teamwork Challenge Match*. (See <G11> and <RSC4>).

Match – A set time period, consisting of *Autonomous Periods* and/or *Driver Controlled Periods*, during which *Teams* play a defined version of Rapid Relay to earn points. See Section 3.

- **Autonomous Period** – A time period during which *Robots* operate and react only to sensor inputs and/or commands pre-programmed by the *Students* into the *Robot* control system.
- **Driver Controlled Period** – A time period during which *Drivers* operate their *Robot*.

Match Type	Participants	Autonomous Period(m:ss)	Driver Controlled Period (m:ss)
Teamwork Challenge	One <i>Alliance</i> , on one <i>Field</i> , made up of two <i>Teams</i> , each with one <i>Robot</i>	None	1:00
<i>Driving Skills Match</i>	One <i>Team</i> , with one <i>Robot</i>	None	1:00
<i>Autonomous Coding Skills Match</i>	One <i>Team</i> , with one <i>Robot</i>	1:00	None

Robot – A machine that has passed inspection, designed to execute one or more tasks autonomously and/or by remote control from a human operator.

Student – Anyone born after May 1, 2009 (i.e., who will be 15 or younger at VEX Worlds 2025). Eligibility may also be granted based on a disability that has delayed education by at least one year. *Students* are the individuals who design, build, repair, and program the *Robot* with minimal *Adult* assistance.

- **Elementary School Student** – Any *Student* born after May 1, 2012 (i.e., who will be 12 or younger at VEX Worlds 2025). *Elementary School Students* may “play up” and compete as *Middle School Students*.
- **Middle School Student** – Any eligible *Student* that is not an *Elementary School Student*.

Team – Two or more *Students* make up a *Team*.

- A *Team* is classified as an *Elementary School Team* if all members are *Elementary School Students*.
- A *Team* is classified as a *Middle School Team* if **any member** is a *Middle School Student*, or if the *Team* is made up of *Elementary School Students* who declare themselves as “Playing Up” as *Middle School Students* by registering their *Team* as a *Middle School Team*.
- Once a *Team* has competed in an event as a *Middle School Team*, that *Team* may not change back to a *Elementary School Team* for the remainder of the season.
- *Teams* may be associated with schools, community/youth organizations, or a group of neighborhood *Students*.

In the context of this Game Manual, *Teams* contain three types of *Student* roles related to *Robot* build, design, and coding. See <G2> and <G4> for more information. *Adults* may not fulfill any of these roles.

- **Builder** – The *Student(s)* on the *Team* who assemble(s) the *Robot*. An *Adult* cannot be a *Builder* on a *Team*. *Adults* are permitted to teach the *Builder(s)* associated concepts, but may never work on the *Robot* without the *Builder(s)* present and actively participating.
- **Coder** – The *Student(s)* on the *Team* who write(s) the computer code that is downloaded onto the *Robot*. An *Adult* cannot be a *Coder* on a *Team*. *Adults* are permitted to teach the *Coder(s)* associated concepts, but may never work on the code that goes on the *Robot* without the *Coder(s)* present and actively participating.
- **Designer** – The *Student(s)* on the *Team* who design(s) the *Robot* to be built for competition. An *Adult* cannot be a *Designer* on a *Team*. *Adults* are permitted to teach the *Designer(s)* associated concepts, but may never work on the design of the *Robot* without the *Designer(s)* present and actively participating.

Violation – The act of breaking a rule in the Game Manual.

- **Minor Violation** – A *Violation* which does not result in a *Disqualification*.
 - Accidental, momentary, or otherwise non-*Score Affecting Violations* are usually *Minor Violations*.
 - *Minor Violations* usually result in a verbal warning from the *Head Referee* during the *Match*, which should serve to inform the *Team* that a rule is being *Violated* before it escalates to a *Major Violation*.

- **Major Violation** – A *Violation* which results in a *Disqualification*.
 - Unless otherwise noted in a rule, all *Score Affecting Violations* are *Major Violations*.
 - If noted in the rule, egregious or intentional *Violations* may also be *Major Violations*.
 - Multiple *Minor Violations* within a *Match* or tournament may escalate to a *Major Violation* at the *Head Referee's* discretion.
- **Score Affecting** – A *Violation* which improves an *Alliance's* score at the end of a *Match*.
 - Multiple *Violations* within a *Match* can cumulatively become *Score Affecting*.
 - When evaluating whether a *Violation* was *Score Affecting*, *Head Referees* will focus primarily on any *Robot* actions that were directly related to the *Violation*.
 - Determining whether a *Violation* was *Score Affecting* can only be done once the *Match* is complete and the scores have been calculated.

Some rules include *Violation Notes* in *red italicized text* to denote special circumstances or provide additional clarifications. If no *Violation Notes* are found in a given rule, then it should be assumed that the above "default" definitions apply.

To determine whether a *Violation* may have been *Score Affecting*, check whether the *Violation* directly contributed to increasing the score of the *Match*. If it did not increase the *Alliance's* score, then the *Violation* was not *Score Affecting*, and it was very likely a *Minor Violation*.

See the following flowchart for more information.

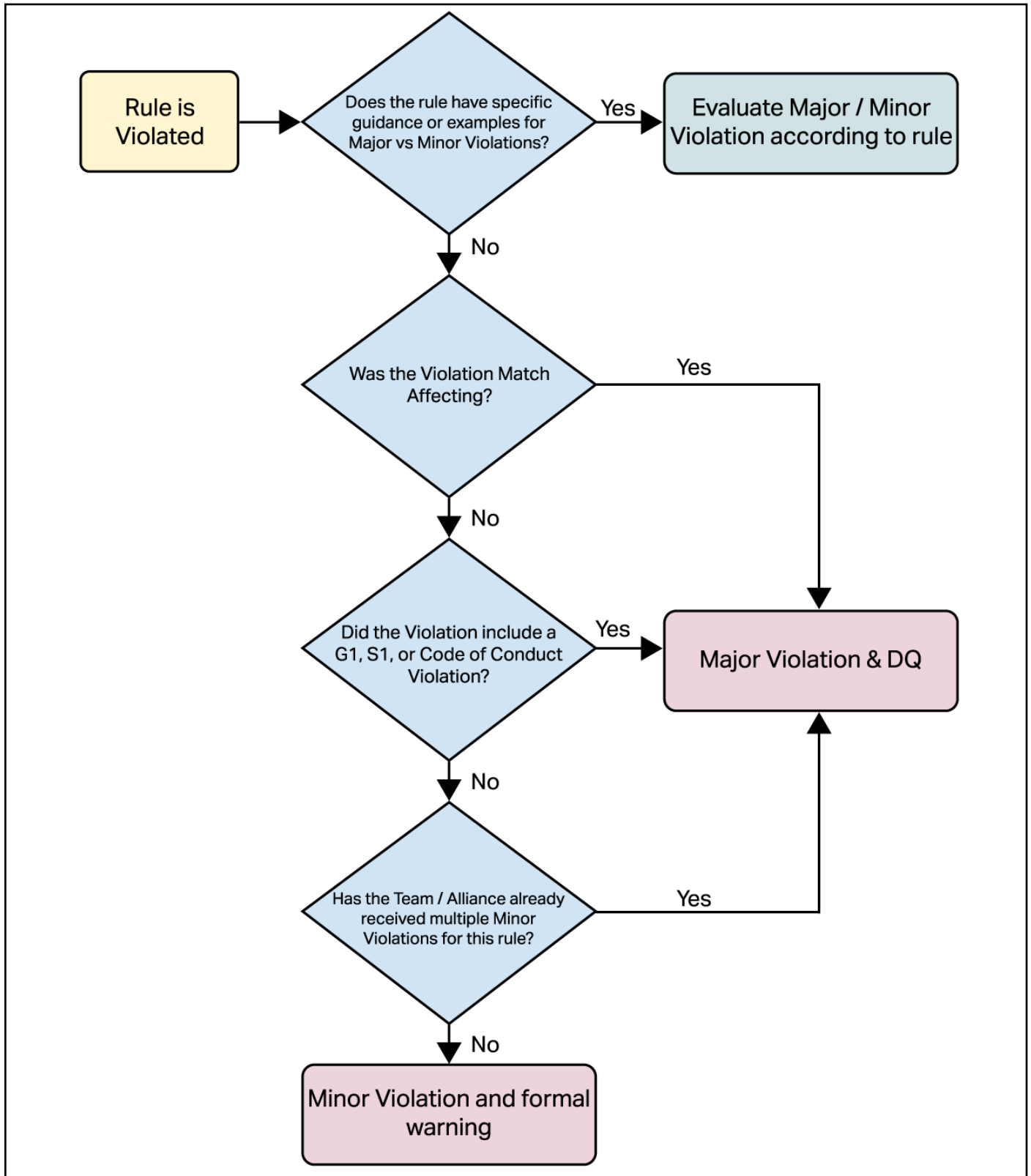
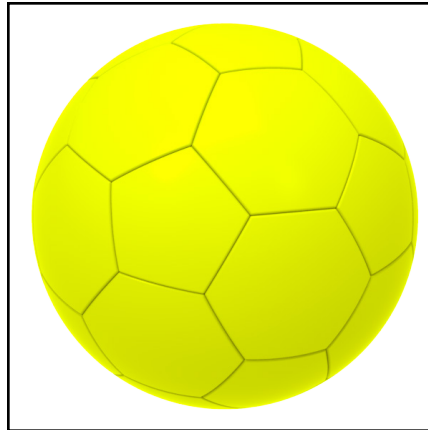

Figure V-1: The process for determining Violations.

Game-Specific Definitions

Ball – A yellow padded, roughly spherical object, with a diameter of approximately 5.9" (150mm) and a weight of approximately 4.2 ounces (120g).

Figure B-1: A Ball.



Cleared – A Switch status. See <SC4>.

Figure C-1: A Cleared Switch.

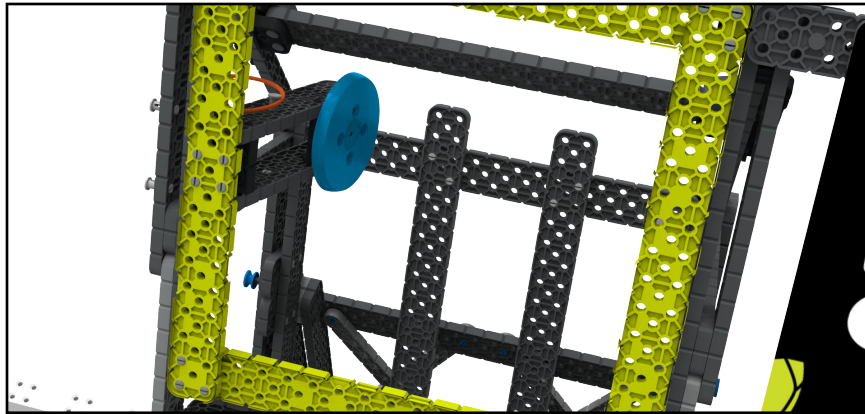

Goal – The act of having Scored a Ball through a Target. See <SC3>.

Goal Wall – A gray and yellow structure, built out of VEX IQ parts, that is attached to the *Field Perimeter* and the *Pickup Zone* pipe. The *Goal Wall* contains four *Targets* and four *Switches*.

Figure GW-1: The Goal Wall.

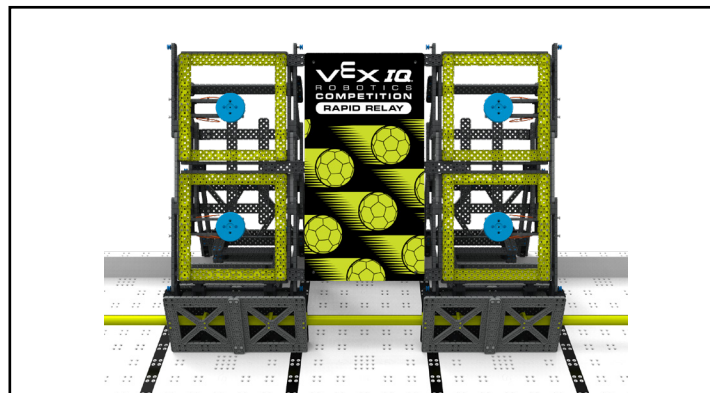

Load – The act of legally introducing a *Ball* into the *Field*. See <SG4>.

Loading Station – The gray structure, built out of VEX IQ parts, that is attached to the *Field Perimeter* opposite the *Goal Wall*. The *Loading Station* is intended to receive *Balls* from a human *Loader* and randomly send them left or right into the *Load Zone*.

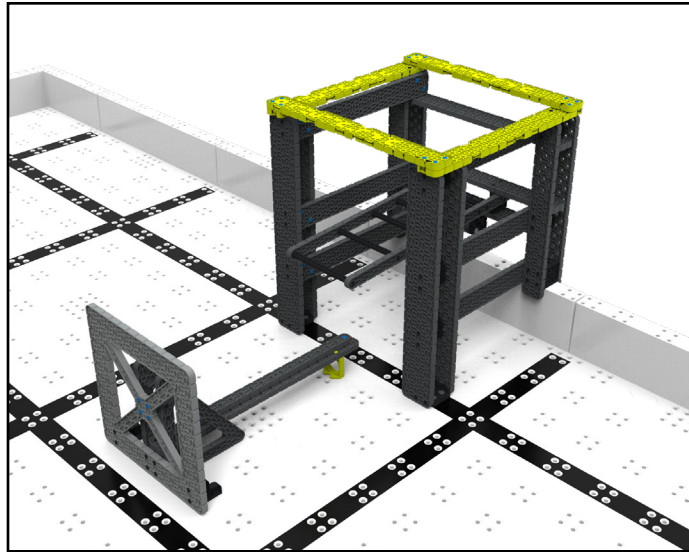

Figure LS-1: The Loading Station.

Load Zone – An area of the *Field* containing the *Loading Station*, bound by the *Field Perimeter* and the inside of the second solid black line from the edge of the *Field* (marked by two yellow VEX IQ beams). The *Load Zone* is an infinitely tall 3-dimensional volume; "reaching over" the black line without contacting the *Floor* would still constitute being partially in the *Load Zone*.

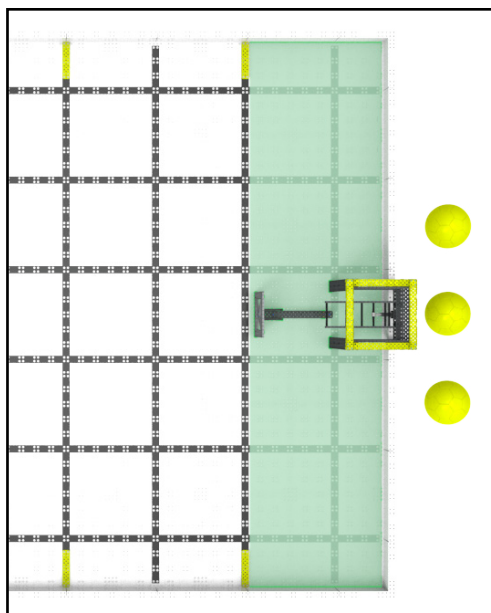
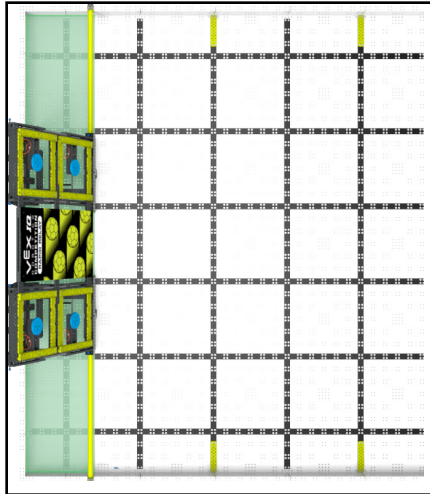

Figure LZ-1: The Load Zone.

Pass – A *Ball/Robot* status used for scoring. See <SC5>.

Pickup Zone – An area of the *Floor* underneath the *Goal Wall*, bound by the *Field Perimeter* and the yellow PVC pipe that runs the length of the Field. The *Pickup Zone* refers to the *Floor* itself; it is not a 3-dimensional volume. See <SG6>.

Figure PZ-1: The Pickup Zone.



Preload – A *Ball* that is loaded into a *Robot* prior to a *Match*. See <SG1>.

Rapid Load - A form of *Loading* which takes place during the *Rapid Load Period*.

Rapid Load Period - A period of the *Match* in which *Balls* may *Loaded* directly into *Starting Zones*, instead of the *Loading Station*. See rules <SG5> and <RSC4>.

Scored - A *Ball*//*Goal* status. See <SC3>.

Starting Zone – One of two areas of the *Field* where *Robots* may begin the *Match*. *Starting Zones* are infinitely tall 3-dimensional volumes, bound by the inside of the *Field Perimeter* walls and the inside edges of the black lines marked by yellow VEX IQ beams. See Figure SZ-1.

Figure SZ-1: A depiction of the Starting Zones.

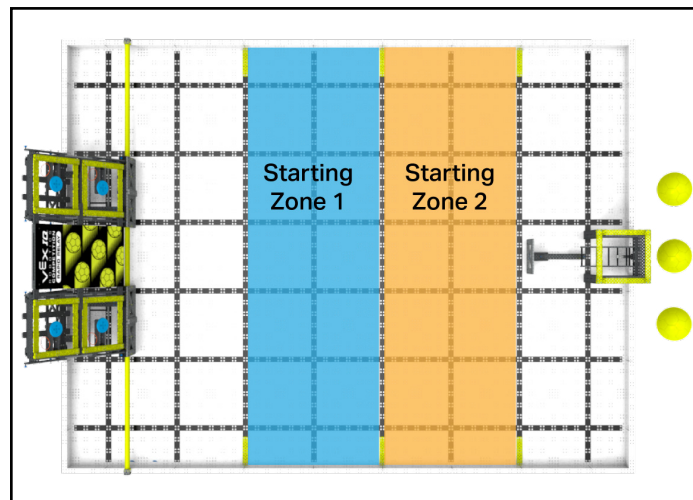

Switch – One of four blue VEX IQ disks, and their supporting structures, found inside of *Targets*.
Switches can be *Cleared* by *Balls*. See <SC4>.

Target – One of four square holes in the angled face of the *Goal Wall* through which *Balls* can be scored.
Targets are approximately 6" square and bordered by yellow VEX IQ beams.

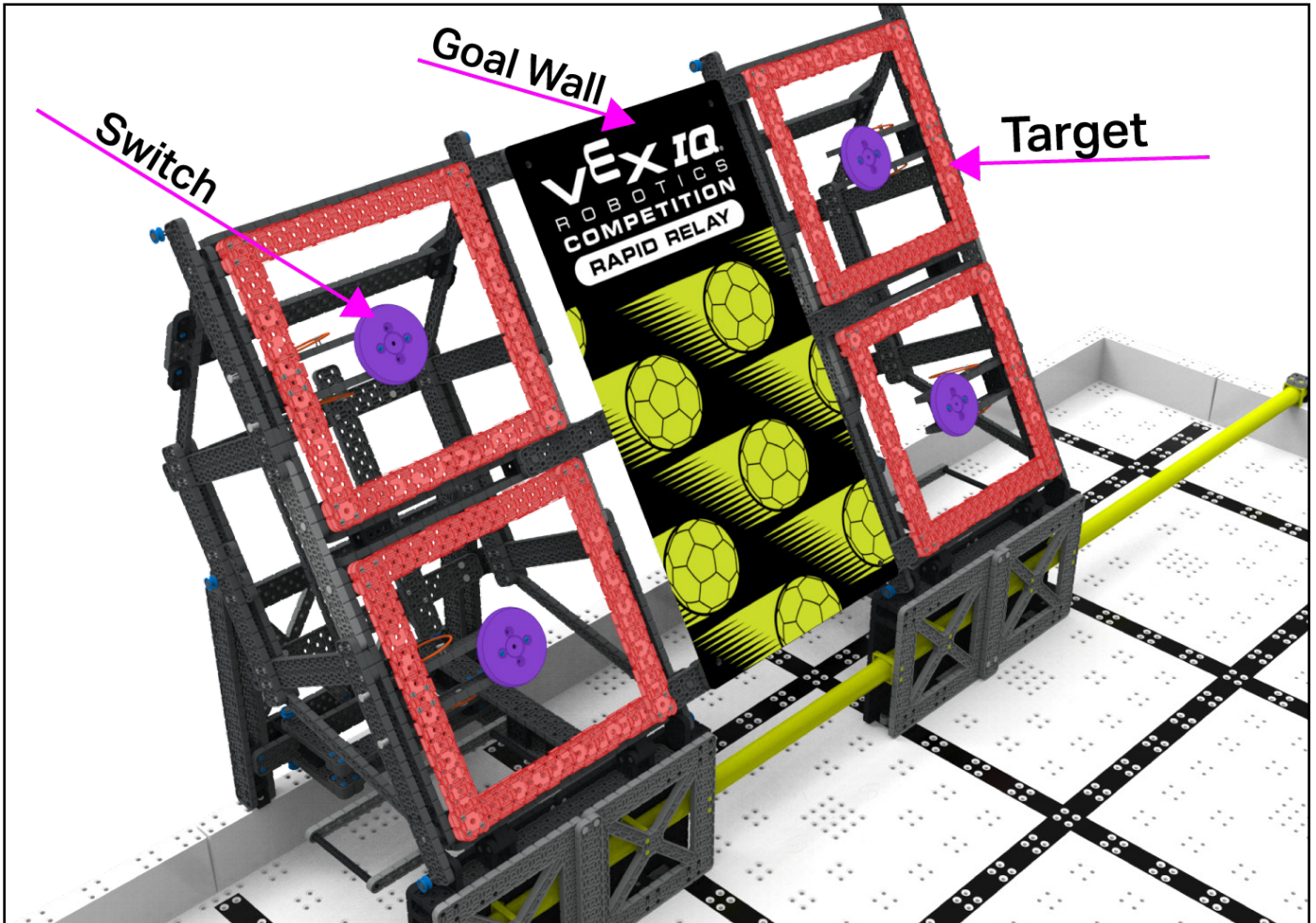

Figure S-1: A depiction of the Goal Wall. Switches are highlighted in Purple, while Targets are highlighted in Red.

Scoring

Each Goal Scored	1 Point
Each Cleared Switch	1 Point
Each Pass - 0 Cleared Switches	1 Point*
Each Pass - 1 Cleared Switch	4 Points
Each Pass - 2 Cleared Switches	8 Points
Each Pass - 3 Cleared Switches	10 Points
Each Pass - 4 Cleared Switches	12 Points

* Maximum of four per Match. See clause C of <SC6>.

<SC1> All Scoring statuses are evaluated **after the Match ends**, once all *Balls*, *Field Elements*, and *Robots* on the *Field* come to rest.

This rule's intent is for *Driver* inputs and *Robot* motion to cease at the end of the *Match*, when the *Match* timer reaches 0:00. A pre-programmed routine which causes *Robot* motion to continue after the end of the *Match* would violate the spirit of this rule. Any Scoring which takes place after the *Match* due to *Robots* continuing to move will not count toward the score and is a *Violation* of this rule.

It is expected that many Rapid Relay *Matches* will have last-second "buzzer-beater" moments. The key moment occurs when the timer display shows 0:00. At many events, a buzzer sound will also play at T=0:00; however, the field timer display takes precedence in the event of any audio discrepancies.

If a *Ball* is released from a *Robot* before this moment, it will be allowed to finish its path and the score will be calculated once it comes to rest. However, if it is released after this moment (i.e., the *Robot* was still moving past T=0:00) it will not count and the *Team* will receive a *Violation* as described below.

In cases where a last-second scoring attempt is "too close to call," *Teams* will generally be given the "benefit of the doubt" and the score will be counted.

Violation Notes

- Because scoring that happens after the Match is not counted, all Violations of <SC1> should be recorded as Minor Violations.
- If a Team receives three Minor Violations within the same event, all future <SC1> Violations at that event will be considered Major Violations and Disqualifications.
- This count does not reset for any reason within an event (e.g., Qualification vs Finals Matches, one of the Team's "dropped score" Matches, etc.).

<SC2> All Scoring statuses are evaluated **visually by a Head Referee**, to the best of their ability within the context of a given *Match*/event.

- a. Referees and other event staff are not allowed to review any videos or pictures from the *Match*. See <T3>.
- b. If there is a concern regarding the score of a *Match*, only the *Drive Team Members* from that *Match*, not an *Adult*, may share their questions with the *Head Referee*. See <T3>.

<SC3> An *Alliance* **Scores a Goal** once a *Ball* is no longer in contact with a *Robot* and has fully passed through a *Target* (i.e., from the "outside" of the *Goal Wall* structure into the "inside" of the *Goal Wall*).

- a. A *Ball* that passes through a *Target* and then bounces back out into the playing field does not count as a *Scored Ball*, and the *Ball* remains in play.

Effectively, this should correspond with the *Ball* falling through the *Goal Wall* and landing in the *Pickup Zone*, and that "land in the *Pickup Zone* moment" can be used for most scoring needs. However, in the event of any jams or other malfunctions, the *Ball* is still considered *Scored* even if it does not touch down to the *Pickup Zone*. See <SG6>.

<SC4> A **Switch is Cleared** once it has been struck by a *Ball* and is no longer parallel with the front face of the *Goal Wall*. *Robots* may not *Clear Switches* by contacting them directly (i.e., without it being part of the process of scoring a *Ball* through that *Target*).

Please don't over-think this rule.

Sometimes a *Switch* gets *Cleared* without scoring a *Ball* through the *Target*, or a *Ball* is *Scored* through a *Target* but the *Switch* is not *Cleared*. That's okay. *Switches* must be *Cleared* as part of normal gameplay, and by *Balls*, not *Robots* or humans. Beyond that, there are no restrictions on what type of *Robot* action, mechanism, strategy, or technique is used to *Score Balls* and *Clear Switches*.

Violation Notes:

- *All Violations of this rule are inherently Score Affecting, and therefore Major Violations.*
- *Violations of this rule should be rare, as Robots should never be designed to contact Switches directly.*

Significant Q&As

- [2023](#) - Referees should not "fix" the state of switches during a match
- [2033](#) - If a *Ball* becomes stuck in a *Target* or *Switch*, it should be cleared by a *Robot*

<SC5> An *Alliance* **receives credit for a Pass** once both *Robots* independently contact a *Ball* before it leaves the *Field*.

- a. For the purposes of this rule, "independent contact" refers to a moment where only one *Robot* is contacting the *Ball*. If both *Robots* are contacting the *Ball*, this is not considered a *Pass*.

- b. Each time a *Ball* is *Loaded*, it is treated like a new *Ball*. Any previous *Robot* contact and/or *Pass* tracking is "reset."
- c. A *Ball* can count for a maximum of one *Pass* each time it is *Loaded* through the *Loading Station*.
- d. *Balls* that are *Rapid Loaded* directly into a *Starting Zone* are not eligible for *Passes*.
- e. Each *Preload Ball* in a *Teamwork Match* can count for a maximum of one *Pass*.

Note: If a referee sees a Pass occur and they are uncertain if it should be counted, Teams should receive the "benefit of the doubt" and the Pass should be recorded. This Note is primarily intended to apply to clauses "C" and "D" of this rule, e.g., if a referee is uncertain whether or not the Ball had been Rapid Loaded.

Significant Q&As

- [2046](#) - A Ball can contact the Floor during a Pass
- [2050](#) - A Ball Loaded through the Loading Station during the Rapid Load Period is eligible for a Pass
- [2053](#) - Preloads are eligible for Passes

<SC6> At the end of a *Match*, an *Alliance* cannot receive points for **more Passes than Goals***.

- a. The point value per *Pass* is determined at the end of the *Match*, based on how many *Switches* have been *Cleared*. See the table at the beginning of this section for details.
- b. All *Passes* should be recorded during the *Match*, regardless of how many *Goals* have been scored at the time the *Pass* occurs. See <SE6>.
- c. *If no *Switches* have been *Cleared* at the end of the *Match*, the maximum number of points that can be received for *Passes* is four (4). The only way this can occur is if *Balls* are repeatedly *Passed* and then sent out of the *Field* without being *Scored*.

<SC7> Rapid Relay is designed to be **scored in "real-time"** as the *Match* is being played. *Passes* and *Goals* should be recorded at the time they occur.

The preferred method to track real-time scoring is to use tablets or mobile devices running the TM Mobile app. If TM Mobile is unavailable, a portable scoreboard may be used by counting *Passes* on one side and *Goals* on the other.

Other scoring methods, such as the VIQRC Hub app or handheld "clicker counters," are permitted but heavily discouraged. When possible, a method that displays the counts to competitors and spectators during the *Match* should always be used.

Each *Match* is required to have a *Head Referee* and at least one *Scorekeeper Referee*. Exact scoring processes may vary depending on a given event's resources, and should be communicated to all *Teams* before *Matches* begin (e.g., during the Event Meeting). One recommended starting point is as follows:

- a. The *Scorekeeper Referee* stands near the *Goal Wall*, and tracks *Scored Balls*.
- b. The *Head Referee* stands mid-field, and tracks *Passes*.
- c. Referees and *Drivers* confirm actions with each other as they occur through means determined before the *Match*, such as verbally or with hand signals. For example, *Drivers* call out "Pass!" and the *Head Referee* responds with "Pass - Check!" to confirm that it has been recorded, or *Drivers* give a thumbs-up that and receive a confirming thumbs-up from the referee.

When possible, two *Scorekeeper Referees* are preferred, so that the *Head Referee* can focus on the *Match* as a whole.

This is a new way to play VIQRC! This rule may be updated to share any "best practices" that are found by early-season events.

Scoring Examples

<SE1>

1. *Robot A* retrieves a *Ball* from the *Loading Station* and launches it down the *Field*.
2. *Robot B* retrieves the *Ball*.
 - a. Scorekeeper records a *Pass*.
3. *Robot B* scores a *Goal*.
 - a. Scorekeeper records a *Goal*.

Result: One *Pass*, one *Goal*.

Explanation: This is a "normal" Rapid Relay cycle.

<SE2>

1. *Robot A* retrieves a *Ball* from the *Loading Station* and launches it down the *Field*.
2. *Robot B* retrieves the *Ball*.
 - a. Scorekeeper records a *Pass*.
3. *Robot B* attempts to score a *Goal*, but misses.
4. The *Ball* bounces off of the *Goal Wall* and back into the *Field*.
5. *Robot A* retrieves the *Ball* and scores a *Goal*.
 - a. Scorekeeper records a *Goal*.

Result: One *Pass*, one *Goal*.

Explanation: The *Ball* never left the *Field*, so it was not yet eligible for additional *Passes*.

<SE3>

1. *Robot A* retrieves a *Ball* from the *Loading Station*.
2. *Robot A* attempts to score a *Goal*, but misses the *Goal Wall* entirely.
3. The *Ball* leaves the *Field*; a human *Loader* retrieves the *Ball* and re-introduces it through the *Loading Station*.
4. *Robot B* retrieves the *Ball* and scores a *Goal*.
 - a. Scorekeeper records a *Goal*.

Result: Zero *Passes*, one *Goal*.

Explanation: As soon as the *Ball* left the *Field*, its previous contact was forgotten. *Robot B*'s contact was not a *Pass*; rather, it became the "first *Robot*" for the new cycle.

<SE4>

1. *Robot A* retrieves a *Ball* from the *Loading Station* and launches it down the *Field*.
2. *Robot B* retrieves the *Ball*.
 - a. Scorekeeper records a *Pass*.
3. *Robot B* attempts to score a *Goal*, but misses.
4. A human *Loader* retrieves the *Ball* and *Loads* it through the *Loading Station*.
5. *Robot A* retrieves the *Ball* and launches it down the *Field*.
6. *Robot B* retrieves the *Ball*.
 - a. Scorekeeper records a *Pass*.
7. *Robot B* scores a *Goal*.
 - a. Scorekeeper records a *Goal*.

Result: Two *Passes*, one *Goal*.

Explanation: It is possible to have a cycle with a *Pass* but no *Goal*. However, if the *Match* were to end at this moment, the *Alliance* would only receive points for one *Pass*. See <SC6>.

<SE5>

- Same steps as Example <SE4> above.
- In step 4, the *Ball* is *Rapid Loaded* into a *Starting Zone* instead.
- Steps 5-7 continue as written.

Result: One *Pass*, one *Goal*.

Explanation: In this scenario, the second contact in step 6 does not count as a second *Pass*.

<SE6>

- Same steps as Example <SE4> above.
- After the *Goal* is scored in step 7, a human *Loader* retrieves the *Ball*, *Rapid Loads* it into a *Starting Zone*, where *Robot B* retrieves and scores it again.

Result: Two *Passes*, two *Goals*.

Explanation: Rule <SC6> only takes effect at the end of the *Match*. This is why all *Passes* are recorded during the *Match*, even if they temporarily exceed the number of *Goals*.

Safety Rules

<S1> Stay safe, don't damage the Field. If, at any time, the *Robot* operation or *Team* actions are deemed unsafe or have damaged any *Field Elements* or *Balls*, the offending *Team* may be *Disabled* and/or *Disqualified* at the *Head Referee's* discretion. The *Robot* will require re-inspection before it may again take the *Field*.

Note: Teams may not step onto the Field at any time. If a Team's Robot requires stepping onto the Field during pre-Match setup, this will be considered a Violation of <S1>, <T6>, and/or <SG1>. The Team's Robot may be removed from the current Match at the Head Referee's discretion.

Violation Notes: Major <S1> Violations should be reported to and/or discussed with the Event Partner during the event, and should be reported to the REC Foundation Rules and Conduct Committee following the event.

<S2> Students must be accompanied by an Adult. No *Student* may attend a VEX IQ Robotics Competition event without a responsible *Adult* supervising them. The *Adult* must obey all rules and be careful to not violate student-centered policies, but must be present for the full duration of the event in the case of an emergency. *Violations* of this rule may result in removal from the event.

Violation Notes: <S2> Violations should be reported to the Event Partner during the event, and should be reported to the REC Foundation Rules and Conduct Committee following the event.

General Game Rules

<G1> Treat everyone with respect. All *Teams* are expected to conduct themselves in a respectful and professional manner while competing in VEX IQ Robotics Competition events. If a *Team* or any of its members (*Students* or any *Adults* associated with the *Team*) are disrespectful or uncivil to event staff, volunteers, or fellow competitors, they may be *Disqualified* from a current or upcoming *Match*. *Team* conduct pertaining to <G1> may also impact a *Team's* eligibility for judged awards. Repeated or extreme violations of <G1> could result in a *Team* being *Disqualified* from an entire event, depending on the severity of the situation.

This rule exists alongside the REC Foundation Code of Conduct. Violation of the Code of Conduct can be considered a *Major Violation* of <G1> and can result in *Disqualification* from a current *Match*, an upcoming *Match*, an entire event, or (in extreme cases) an entire competition season. The Code of Conduct can be found [here](#).

More information regarding the event Code of Conduct process can be found at the [RECF Library](#).

We all can contribute to creating a fun and inclusive event experience for all event attendees. Some examples include:

When dealing with difficult and stressful situations, it is...

- Okay for *Teams* to be gracious and supportive when your *Alliance* partner makes a mistake.
- Not okay for *Teams* to harass, tease, or be disrespectful to your *Alliance* partner when a *Match* does not go your way.

When a *Team* does not understand a *Match* ruling or score, it is...

- Okay for *Drive Team Members* to consult with a *Head Referee* to discuss a ruling per the process outlined in <T3> in a calm and respectful manner.
- Not okay for *Drive Team Members* to continue arguing with the *Head Referee* after a decision has been finalized, or for *Adults* to approach a *Head Referee* with ruling/scoring concerns.

When *Teams* are getting ready for an upcoming *Match*, it is...

- Okay for *Teams* in an *Alliance* to develop a game strategy that utilizes the strengths of both *Robots* to cooperatively solve the game.
- Not okay for one *Team* in an *Alliance* to ask another *Team* to sit in a corner during the *Match* or to intentionally play beneath their abilities.

Violation Notes: Any Violation of <G1> may be considered a Major Violation and should be addressed on a case-by-case basis. Teams at risk of a Major <G1> Violation due to multiple disrespectful or uncivil behaviors will usually receive a "final warning", although the Head Referee is not required to provide one. All Major <G1> Violations/Disqualifications should be reported to and/or discussed with the Event Partner during the event, and should be reported to the REC Foundation Rules and Conduct Committee following the event.

<G2> VIQRC is a student-centered program. *Adults* should not make decisions about the *Robot's* build, design, or gameplay, and should not provide an unfair advantage by providing 'help' that is beyond the *Students'* independent abilities. *Students* must be prepared to demonstrate an active understanding of their *Robot's* design, construction, and programming to judges or event staff.

Some amount of *Adult* mentorship, teaching, and/or guidance is an expected and encouraged facet of VEX competitions. No one is born an expert in robotics! However, obstacles should always be viewed as teaching opportunities, not problems for an *Adult* to solve for the *Team*.

When a mechanism falls off, it is...

- Okay for an *Adult* to help a *Student* investigate why it failed, so it can be improved.
- Not okay for an *Adult* to investigate or put the *Robot* back together.

When a *Team* encounters a complex programming concept, it is...

- Okay for an *Adult* to guide a *Student* through a flowchart to understand its logic.
- Not okay for an *Adult* to write a premade command for that *Student* to copy / paste.

During *Match* play, it is...

- Okay for an *Adult* to provide cheerful, positive encouragement as a spectator.
- Not okay for an *Adult* to explicitly shout step-by-step commands from the audience.

This rule operates in tandem with the [REC Foundation Student Centered Policy](#), which is available on the REC Foundation website for *Teams* to reference throughout the season.

Violation Notes: Potential Violations of this rule will be reviewed on a case-by-case basis. By definition, all Violations of this rule become Score Affecting as soon as a Robot which was built or programmed by an Adult scores points in a Match. All reported and/or suspected <G2> Violations should be reported to the Event Partner during the event, and should be reported to the REC Foundation Rules and Conduct Committee following the event.

<G3> Use common sense. When reading and applying the various rules in this document, please remember that common sense always applies in the VEX IQ Robotics Competition.

Some examples may include:

- If there is an obvious typographical error (such as "per <T5>" instead of "per <G5>"), this does not mean that the error should be taken literally until corrected in a future update.
- Understand the realities of the VEX IQ *Robot* construction system. For example, if a *Robot* could hover above the *Field* for a whole *Match*, that would create loopholes in many of the rules. But... they can't. So... don't worry about it.
- When in doubt, if there is no rule prohibiting an action, it is generally legal. However, if you have to ask whether a given action would violate <S1>, <G1>, or <T1> then

that's probably a good indication that it is outside the spirit of the competition. On the other hand, if there's not a rule that makes a *Robot* part legal, it's not allowed.

- In general, *Teams* will be given the "benefit of the doubt" in the case of accidental or edge-case rules infractions. However, there is a limit to this allowance, and repeated or strategic infractions will still be penalized.

<G4> The Robot must represent the skill level of the Team. Each *Team* must include *Drivers*, *Coder(s)*, *Designer(s)*, and *Builder(s)*; many also include *notebook(s)*. No *Student* may fulfill any of these roles for more than one VEX IQ Robotics Competition *Team* in a given competition season. *Students* may have more than one role on the *Team* (e.g., the *Designer* may also be the *Builder*, the *Coder*, and a *Driver*).

- Team* members may move from one *Team* to another for non-strategic reasons outside of the *Team's* control.
 - Examples of permissible moves may include, but are not limited to, illness, changing schools, conflicts within a *Team*, or combining/splitting *Teams*.
 - Examples of strategic moves in *Violation* of this rule may include, but are not limited to, one *Coder* "switching" *Teams* in order to write the same program for multiple *Robots*, or one *Student* writing the Engineering Notebook for multiple *Teams*.
 - If a *Student* leaves a *Team* to join another *Team*, <G4> still applies to the *Students* remaining on the previous *Team*. For example, if a *Coder* leaves a *Team*, then that *Team's Robot* must still represent the skill level of the *Team* without that *Coder*. One way to accomplish this would be to ensure that the *Coder* teaches or trains a "replacement" *Coder* in their absence.

Points i and ii are intended to represent real-world situations that are found in industry engineering. If a vital member of a professional engineering team were to suddenly leave, the remaining members of the team should still be capable of working on / maintaining their project.

- When a *Team* qualifies for a Championship event (e.g., States, Nationals, Worlds, etc.) the *Students* on the *Team* attending the Championship event are expected to be the same *Students* on the *Team* that was awarded the spot. *Students* can be added as support to the *Team*, but may not be added as *Drivers* or *Coders* for the *Team*.
 - An exception is allowed if only one (1) member of the *Team* is able to attend the event. The *Team* can make a single substitution of a *Driver* or *Coder* for the Championship event with another *Student*, even if that *Student* has competed on a different *Team*. This *Student* will now be on this new *Team* and may not substitute back to the original *Team* during the season.
- Loaders* are an exception to this rule. If a *Team* only has two *Students* and is unable to field a three-*Student Drive Team*, they may choose from one of the following options:
 - For a given *Match*, they may substitute in a *Student* from their *Alliance Partner's Team* as a temporary *Loader*. They may do this in as many *Matches* as needed.
 - For a given event, they may substitute in a *Student* from another *Team* to be their *Loader* for the duration of the event. This *Student* will effectively become a member of the new *Team* for that event, and cannot fill a role on the original *Team* (or on any other *Teams*) for the remainder of that event.

- iii. There is no requirement for a Drive Team to have a *Loader*; if desired, they can play the *Match* with only two *Drivers*, and rely on their *Alliance Partner's Loader*.

Violation Notes:

- *Violations of this rule will be evaluated on a case-by-case basis, in tandem with the REC Foundation Student Centered Policy as noted in <G2>, and the REC Foundation Code of Conduct as noted in <G1>. All reported and/or suspected <G4> Violations should be reported to the Event Partner during the event, and should be reported to the REC Foundation Rules and Conduct Committee following the event.*
- *Regarding point C and substitute Loaders: It would be severely outside the intent of this rule, and a potential Code of Conduct / <G1> Violation, for a Team to forcefully "offer" a substitute onto their Alliance Partner, and/or ask their Alliance Partner's Loader to sit out for a Match.*

Event Partners should bear in mind <G3>, and use common sense when enforcing this rule. It is not the intent to punish a Team who may change Team members over the course of a season due to illness, changing schools, conflicts within a Team, etc.

Event Partners and referees are not expected to keep a roster of any Student who has ever been a Driver for one day. This rule is intended to prohibit any instance of loaning or sharing Team members for the sole purpose of gaining a competitive advantage.

<G5> Robots begin the Match in the starting size. At the beginning of a *Match*, each *Robot* must fit within an 23" wide x 73" long x 15" high (584mm x 1854mm x 381mm) volume, as checked during inspection per <R4>.

Violation Notes: Any Violation of this rule will result in the Robot being removed from the Field prior to the start of the Match; rules <R3d> and <T6> will apply until the situation is corrected. They will not receive a Disqualification, but they will not be permitted to play in the Match.

<G6> Keep your Robot together. *Robots* may not intentionally detach parts or leave mechanisms on the *Field* during any *Match*. Parts that become unintentionally detached from the *Robot* are no longer considered to be part of the *Robot* and can be either left on the *Field* or collected by a *Drive Team Member* (utilizing <G10>).

Note: Adding or replacing mechanisms on a Robot mid-Match (e.g., during a <G10> interaction) is considered a Violation of the intent and spirit of this rule.

Significant Q&As:

- [2056](#) - Detached parts that remain contained within the Robot may be legal

<G7> Don't damage the Field. *Robot* interactions which damage the *Field* or any *Field Elements* are prohibited. For the purpose of this rule, "damage" is defined as anything which requires repair in order to begin the next *Match*, such as causing part of the *Loading Station* to detach from the *Field*.

Teams are responsible for the actions of their Robots at all times, especially when interacting with the Goal Wall and the Loading Station. If a Team chooses to repeatedly ram full-speed into a Field Element, it will be hard to convince a Head Referee that any damage caused was "accidental."

Violation Notes:

- *In most cases, accidental Field damage should only be considered a Minor Violation.*
- *Egregious, intentional, or repeated accidental/Minor Violations may escalate to a Major Violations at the Head Referee's discretion.*

<G8> Drivers drive your Robot, and stay in the Driver Station. During a Match, Robots may only be operated by that Team's Drivers and/or software running on the Robot's control system. Drivers must remain in their Driver Station, except when legally interacting with their Robot per <G10>.

Drive Team Members are prohibited from any of the following actions during a Match:

- Bringing/using any sort of communication devices into the Driver Station, including wireless headphones of any kind, even if powered off. Non-headphone devices with communication features turned off (e.g., a phone in airplane mode) are allowed.
- Standing on any sort of object during a Match, regardless of whether the Field is on the floor or elevated.
- Bringing/using additional materials to simplify the game challenge during a Match.

Point C is intended to refer to non-Robot-related items that directly influence gameplay, such as using a ramp to assist with the Loading Station. Provided no other rules are violated, and the items do not pose any safety or field damage risks, the following examples are not considered Violations of <G8>:

- Materials used before or after a Match, such as a pre-Match alignment aid, or a carrying case for Robots/Controllers
- Strategic aids, such as a whiteboard or clipboard
- Earplugs, gloves, or other personal accessories

Note: Drive Team Members are the only Team members that are allowed to be in the Driver Station during a Match. Adults (other than event staff) are not permitted to be in the Driver Station during a Match.

Note 2: Loaders are not restricted to the Driver Station, and may move around the Field freely.

Violation Notes: Major Violations of this rule are not required to be Score Affecting, and could invoke Violations of other rules, such as <G1>, <G2>, or <G11>.

<G9> Hands out of the Field. During a *Match*, *Drive Team Members* are prohibited from making intentional contact with any *Field Element*, *Robot*, or *Ball* that has been introduced to the *Field*, except for the allowances in <G10>, <RSC8>, <SG4> and/or <SG6>.

Note: Any concerns regarding Field Element starting positions should be raised with the Head Referee prior to the Match. Team members may never adjust Field Elements themselves.

<G10> Handling the Robot mid-match is allowed under certain circumstances. If a *Robot* goes completely outside the playing *Field*, gets stuck, tips over, or otherwise requires assistance, the *Drive Team Members* may retrieve & reset their *Robot*. To do so, they must do the following:

- a. Signal the referee by placing their VEX IQ Controller on the ground.
- b. Any *Balls* being controlled by the *Robot* while being handled must be removed from the *Field*, and can be returned through the *Loading Station* or *Rapid Loaded* as appropriate based on the *Match* timer.
 - i. In the context of this rule, "controlled" implies that the *Robot* was manipulating the *Ball*, and not simply touching it. For example, if the *Ball* moves with the *Robot* either vertically or while turning, then the *Robot* is "controlling" the *Ball*.
 - ii. Clause d of <SG3> applies to *Balls* that are removed from the *Field* during the last 15 seconds of the *Match*.
- c. The *Robot* must be placed back into a legal position that meets the criteria listed in clauses a & b of <SG1>.

As described in rule <S1>, *Students* cannot step into the *Field* at any time during a *Match*. If the *Drive Team Members* cannot reach the *Robot* due to the *Robot* being in the center of the *Field*, they may ask the *Head Referee* to pick up the *Robot* and hand it to the *Drive Team Members* for placement according to the conditions above.

Note: If any Balls are preventing the Robot from being legally placed, such as resting against the Field Perimeter wall, they may be removed from the Field and reintroduced (in accordance with <SG3>).

Violation Notes: This rule is intended to allow Teams to fix damaged Robots or help get their Robots "out of trouble." Strategically exploiting this rule may be considered a Minor Violation or Major Violation at the Head Referee's discretion.

<G11> A Team's two Drivers switch Controllers midway through the Match. In a given *Match*, up to two (2) *Drivers*, plus one *Loader*, may be in the *Driver Station* per *Team*. The two *Drivers* must switch their controller between twenty-five seconds (0:25) and thirty-five seconds (0:35) remaining in the *Match*.

- a. No *Driver* shall operate a *Robot* for more than thirty-five seconds (0:35).
- b. The second *Driver* may not touch their *Team's* controls until the controller is passed to them.
- c. Once the controller is passed, the first *Driver* may no longer touch their *Team's* controls.
- d. A *Driver* cannot also be a *Loader* in the same *Match*. If a *Team* only has two members, they must exercise one of the substitute *Loader* options listed in rule <G4c>.

Note: If only one Driver is present, this rule still applies and they must cease Robot operation after the first thirty-five (0:35) seconds of the Match.

Violation Notes: At a minimum, any Violation of this rule is considered a Minor Violation. Whether it escalates to a Major Violation or not is dependent upon the Head Referee's judgment regarding:

- *Prior warnings or Violations*
- *Any Score Affecting actions that were a direct result of the Violation, such as the first Driver scoring additional points after 35 seconds of driving*

Significant Q&As:

- [2105](#) - Clause D does not require that substitute Loaders be from the Team's organization

Specific Game Rules

<SG1> **Pre-match setup.** At the beginning of a *Match*, the *Robot* must be placed such that it is:

- Satisfying all constraints listed in <R4> (i.e., fully contained within one *Starting Zone* and no taller than 15").
- Contacting the inside of the *Field Perimeter* wall.
- Contacting exactly one (1) *Preload*.
- Completely stationary (i.e., no motors or other mechanisms in motion). Pre-charging a pneumatic system (i.e., having the Pneumatic Pump running prior to the *Match*) is the only permitted exception to this rule.
- Not occupying the same *Starting Zone* as the *Alliance partner Robot*.

There are no specific starting positions, as long as the above criteria are met. Per <T6>, *Robots* must arrive at the *Field* ready to play with minimal additional setup. Repeated delays may result in a *Violation* of <G1> and/or removal of the *Robot* from the current *Match* at the *Head Referee's* discretion.

Violation Notes: Any Violation of this rule will result in the Robot being removed from the Field prior to the start of the Match; rules <R3d> and <T6> will apply until the situation is corrected. They will not receive a Disqualification, but they will not be permitted to play in the Match.

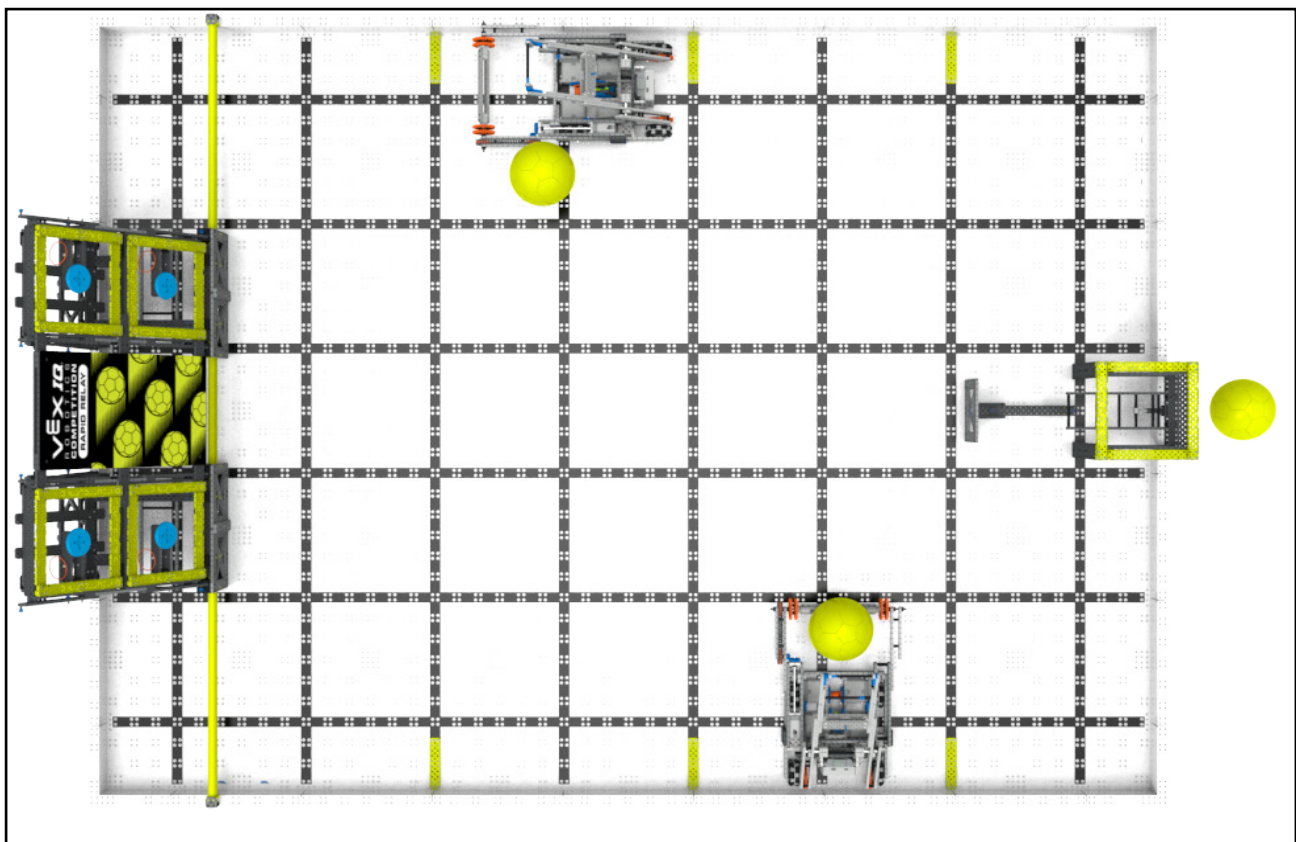

Figure SG-1: Robots in a legal pre-Match starting position.

<SG2> Robot expansion is limited. Robots may not expand beyond the 23" x 73" horizontal or 15" vertical starting size limits at any time during a *Match*. The 15" height limit is a "virtual ceiling," meaning that no part of a *Robot* may exceed 15" above the *Floor*, regardless of *Robot* orientation.

Violation Notes: It is expected that momentary Minor Violations may occur, such as when a Robot drives over the VEX IQ beams that mark the Starting Zones. These will likely only result in a verbal warning and will not be recorded as Violations if no gameplay advantage occurs.

<SG3> Keep Balls in the Field. It is expected that some *Balls* may leave the *Field* without being scored. When this happens, they may be retrieved by a *Loader* and legally *Loaded* through the *Loading Station*.

- a. "Leaving the *Field*" means that a *Ball* is outside of the *Field Perimeter* and no longer in contact with the *Field*, *Field Elements*, other *Balls*, or *Robots*. A *Ball* that is scored through a *Target* is not considered to have left the *Field*.
- b. If a *Ball* is removed from a *Robot* during a <G10> interaction, it is considered "out of the *Field*" as soon as it is no longer in contact with any *Robots*.
- c. If a *Ball* is on its way out of the *Field* (as determined by the *Head Referee*), but is deflected back into the field by a *Drive Team Member*, field monitor, ceiling/wall, or other external factor, <SG3> would still apply. This *Ball* should be considered "out of the *Field*," removed by a *Head Referee*, and given to a *Loader*.
 - i. If the redirection occurred due to contact with a *Drive Team Member*, it will be at the *Head Referee's* discretion whether <G9> or <SG3> should apply.
- d. *Balls* which leave the *Field* during the *Rapid Load Period* must be returned through the *Loading Station*; they may not be *Loaded* directly into a *Starting Zone*.

<SG4> Using the Loading Station. *Balls Loaded* through the *Loading Station* must meet the following criteria:

- a. No more than two (2) *Balls* may be in play at any one time (i.e., the next *Ball* should not be *Loaded* until a previous *Ball* is either scored or leaves the *Field*).
- b. The *Loader* must be the last human to contact the *Ball* before it is released.
- c. The *Loader's* hand may not cross into the volume of the *Loading Station* at any time.
- d. No *Robot(s)* may be in the *Load Zone* at the time the *Ball* is released by the *Loader*.
- e. If a *Ball* is introduced improperly through the *Loading Station*, the *Head Referee* will verbally notify the *Loader* as soon as possible (e.g., "your hand crossed, load that one again"). The *Ball* must then be removed from the *Load Zone* by a *Loader* before it is retrieved by a *Robot* and legally *Loaded* again.
- f. If a *Ball* is introduced improperly outside of the *Loading Station* (e.g., into the middle of the *Field* prior to the *Rapid Load Period*), the *Ball* must be retrieved by a referee and handed to a *Loader*.

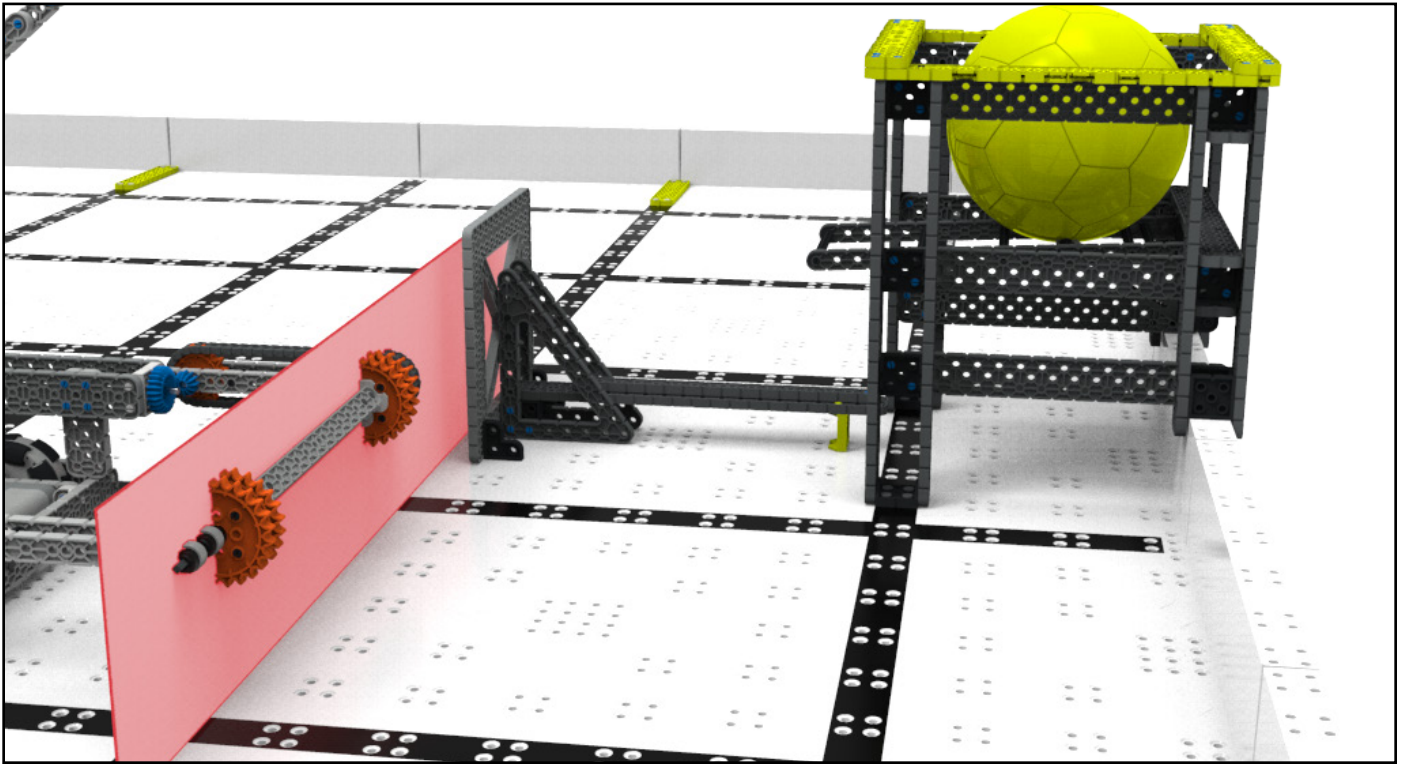

Figure SG-4: This Robot is breaking the plane of the Loading Zone while the Ball is being entered. This Ball would need to be removed from the Loading Zone, and legally reintroduced.

Note: The legal edge of the *Load Zone* is on the side of the black line closest to the *Loading Station*. The other edge of the black line is intended to be a "warning zone." Robots touching or breaking the plane of this line during a Load may receive a "close call" warning from the *Head Referee*. This warning is not a *Violation*, as long as the Robot never enters the *Load Zone*.

Violation Notes:

- *Most Violations which are not Score Affecting (i.e., where a Robot never retrieves the illegally Loaded Ball) are considered Minor Violations, even after repeated occurrences. The primary penalty is intended to be the Match time that is lost from retrieving and re-introducing the Ball.*
- *Teams are responsible for their own actions. Violations will always be given to the Loader's Team. Violations of point D where the Loader and Robot are from different Teams will be given to both Teams.*
- *Robot contact with the Loading Station while a Ball is being Loaded is considered an egregious Violation of point D for the Robot's Team, and is an exception to all previous notes. Repeated occurrences by the same Robot, even if not Score Affecting, may escalate to a Major Violation for that Robot's Team at the Head Referee's discretion.*

Significant Q&As:

- [2014](#) - There is a not a possession limit
- [2032](#) - Loaders can toss the Ball from the Pickup Zone to the Loading Zone
- [2052](#) - If the human Loader is no longer contacting a Ball that is being (or has been) Loaded, it is legal for a Robot to enter the Load Zone
- [2083](#) - Loaders can load new ball immediately after current ball is Scored

<SG5> Loading during the Rapid Load Period. During the last fifteen (15) seconds of the *Match*, Loaders have the option to introduce *Balls* directly onto the *Starting Zone* (i.e., without using the *Loading Station*).

- Cluses "A" and "B" of <SG4> must still be satisfied during the *Rapid Load Period*.
- Rapid Load Balls* must be released by the *Loader* directly onto the *Floor* inside a *Starting Zone* before being contacted by a *Robot*.
- Balls* may never be in contact with both a *Robot* and a human *Loader* at the same time.
- Rapid Load Balls* may only be removed from the *Starting Zone* by a *Robot* action (i.e., cannot be bounced, rolled, or otherwise removed from the *Starting Zone* by a *Loader*).
- Rapid Load Balls* are not eligible to receive credit for *Passes*.
- The human *Loader* may not contact the *Floor* while introducing the *Match Load* (e.g., cannot step into or place a hand on the *Floor* to reach the center of the *Field*)."

If a *Ball* is *Rapid Loaded* improperly, the *Ball* must be retrieved by a referee, given to a *Loader*, and re-Loaded legally before it may be retrieved by a *Robot*.

Note: Although it is not required, Robots are highly recommended to remain some distance away from the Ball entirely until the Loader's hand has clearly been removed. This will make clauses "B" and "C" abundantly clear to Head Referees, and help them to verify clauses "A" and "D".

Note 2: Although it is not required, placing the Ball gently down onto the Field without any additional motion is highly recommended. Unorthodox strategies, such as "tossing" or "rolling" the Ball, will not receive any "benefit of the doubt" if the Head Referee cannot clearly confirm that all criteria have been met (especially clauses "B" and "D").

Violation Notes:

- *Teams are responsible for their own actions. Violations that involve a Loader and Robot from opposite Teams will be given to both Teams.*
- *It is expected that most Violations of this rule will be accidental. In accidental cases that end up being Score Affecting (i.e., an illegally-Loaded Ball scores a Goal), the first occurrence during a Qualification Match may be treated as a Minor Violation and a "final warning" for any future Violations.*

- *Score Affecting Violations during a Finals Match (accidental and intentional) must be treated as a Major Violation.*
- *Repeated, intentional, or egregious Violations may escalate to a Major Violation at the Head Referee's discretion. One example of an egregious Violation would be placing a Ball directly onto a Robot without ever contacting the Floor.*

<SG6> Retrieving Balls from the Pickup Zone. Once a Goal is scored, that Ball will fall through the Goal Wall and into the Pickup Zone. This rule also applies to Balls that land in the Pickup Zone without being scored.

- Once the Ball contacts the Floor of the Pickup Zone, a Loader may retrieve it. They may not reach into the Field until the Ball contacts the Floor.
- A Ball which has been Scored through a Target may not be used for additional scoring or Switch Clearing until it is retrieved by a Loader and legally re-Loaded.

Note: Although not explicitly required, it is highly recommended for Loaders to have a designated "staging location" to rest their hands while waiting for a Ball (such as the outside face of the Field Perimeter). This will help make it abundantly clear to the Head Referee that point A is not being Violated.

If a Scored Ball gets stuck inside the Goal Wall structure after passing through a Target and does not make it to the Pickup Zone, a referee may free that Ball by carefully reaching into the Goal Wall. Balls that have not passed entirely through a Target should not be retrieved by a referee, although it is expected that they may fall into or out of the Goal Wall if an adjacent Scored Ball is removed. In most cases, a gentle nudge will be all that is needed to move the Scored Ball into the Pickup Zone. Extreme circumstances, such as interference with gameplay during this interaction, may warrant a Match replay at the Head Referee and Event Partner's discretion (see <T7>).

Violation Notes:

- *Accidental Violations of point A, such as reaching over the Field but not touching a Ball, should be treated as warnings / Minor Violations. Egregious or repeated Violations that result in retrieving a Ball before it contacts the Floor of the Pickup Zone are inherently Score Affecting, and will escalate to a Major Violation at the Head Referee's discretion.*
- *The intent of point B is to prevent Robots from retrieving Balls out of the Pickup Zone. Violations of this rule should be rare, as Robots should never be designed to do so.*

Section 3

The Robot

Description

Every *Robot* must pass a full inspection before being cleared to participate in the VEX IQ Robotics Competition. This inspection will ensure that all *Robot* rules and regulations are met. Initial inspections will typically take place during team check-in / practice time. Every *Team* should use the rules below as a guide to pre-inspect their *Robot* and ensure that it meets all requirements.

Inspection Rules

<R1> One Robot per Team. Only one (1) *Robot* will be allowed to participate per *Team* at a given event. Though it is expected that *Teams* will make changes to their *Robots* at the event, a *Team* is limited to only one (1) *Robot*, and a given *Robot* may only be used by one (1) *Team*. The VEX IQ system is intended to be a mobile robotics design platform. As such, a VEX IQ Robotics Competition *Robot*, for the purposes of the VEX IQ Robotics Competition, has the following subsystems:

- Subsystem 1: Mobile robotic base including wheels, tracks, or any other mechanism that allows the *Robot* to navigate the majority of the flat playing *Field* surface. For a stationary *Robot*, the robotic base without wheels would be considered Subsystem 1.
- Subsystem 2: Power and control system that includes a VEX IQ legal battery, a VEX IQ control system, and associated Smart Motors for the mobile robotic base.
- Subsystem 3: Additional mechanisms (and associated Smart Motors) that allow manipulation of *Balls* or navigation/manipulation of *Field Elements*.

Given the above definitions, a minimum *Robot* for use in any VEX IQ Robotics Competition event (including Skills Challenges) must consist of subsystems 1 and 2 above. Thus, if you are swapping out an entire subsystem 1 or 2, you have now created a second *Robot* and are no longer legal.

- a. *Teams* may not compete with one *Robot* while a second is being modified or assembled at a competition.
- b. *Teams* may not have an assembled second *Robot* on hand at a competition that is used to repair or swap parts with the first *Robot*.
- c. *Teams* may not switch back and forth between multiple *Robots* during a competition. This includes using different *Robots* for Skills Challenge, *Qualification Matches*, and/or *Finals Matches*.
- d. Multiple *Teams* may not use the same *Robot*. Once a *Robot* has competed under a given *Team* number at an event, it is "their" *Robot*; no other *Teams* may compete with it for the duration of the competition season.

The intent of <R1a>, <R1b>, and <R1c> is to ensure an unambiguous level playing field for all *Teams*. *Teams* are welcome (and encouraged) to improve or modify their *Robots* between events, or to collaborate with other *Teams* to develop the best possible game solution.

However, a *Team* who brings and/or competes with two separate *Robots* at the same tournament has diminished the efforts of a *Team* who spent extra design time making sure that their one *Robot* can accomplish all of the game's tasks. A multi-*Team* organization that shares a single *Robot* has diminished the efforts of a multi-*Team* organization that puts in the time, effort, and resources to undergo separate individual design processes and develop their own *Robots*.

To help determine whether a *Robot* is a "separate *Robot*" or not, use the Subsystem definitions found in <R1>. Above that, use common sense as referenced in <G3>. If you can place two complete and legal *Robots* on a table next to each other, then they are two separate *Robots*. Trying to decide if changing a pin, a wheel, or a motor constitutes a separate *Robot* is missing the intent and spirit of this rule.

<R2> Robots must represent the Team's skill level. The *Robot* must be designed, built, and programmed by members of the *Teams*. *Adults* are permitted to mentor and teach design, building, and programming skills to the *Students* on the *Team*, but may not design, build, or program that *Team's Robot*.

In VIQRC, we expect *Adults* to teach fundamental *Robot* principles like linkages, drive-trains, and manipulators, then allow the *Students* to determine which designs to implement and build on their *Robot*.

Similarly, *Adults* are encouraged to teach the *Students* how to code various functions involving applicable sensors and mechanisms, then have the *Students* program the *Robot* from what they have learned.

<R3> Robots must pass inspection. The *Team's Robot* must pass inspection before being allowed to participate in any *Matches*. Noncompliance with any *Robot* design or construction rule will result in removal from *Matches* or *Disqualification* of the *Robot* at an event until the *Robot* is brought back into compliance, as described in the following subclauses.

- a. Significant changes to a *Robot*, such as a partial or full swap of Subsystem 3, must be re-inspected before the *Robot* may compete again.
- b. All possible functional *Robot* configurations must be inspected before being used in competition.
- c. *Teams* may be asked to submit to spot inspections by *Head Referees*. Refusal to submit will result in *Disqualification*.
- d. If a *Robot* is determined to not be legal before a *Match* begins, the *Robot* will be removed from the *Field*. A *Driver* may remain so that the *Team* does not get assessed a "no-show" (per <T5>).
- e. *Robots* which have not passed inspection (i.e., that are in *Violation* of one or more *Robot* rules) will not be permitted to play in any *Matches* until they have done so. <T6> will apply to any *Matches* that occur until the *Robot* has passed inspection.

- f. If a *Robot* has passed inspection, but is later found to be in *Violation* of a *Robot* rule during or immediately following a *Match*, then they will be Disqualified from that *Match* and <R3d>/<T6> will apply until the *Violation* is remedied and the *Team* is re-inspected.
- g. All inspection rules are to be enforced at the discretion of the *Head Referee* within a given event. *Robot* legality at one event does not automatically imply legality at future events. *Robots* which rely on "edge-case" interpretations of subjective rules, such as whether a decoration is "non-functional" or not, should expect additional scrutiny during inspection.

<R4> Starting configuration. At the start of each *Match*, the *Robot* must be able to satisfy the following constraints:

- a. Only be contacting the *Floor* and the inside face of the *Field Perimeter*.
- b. Fit within the volume of a *Starting Zone*.
- c. Be no taller than 15" (i.e., roughly the height of the yellow VEX IQ beams above the bottom two *Targets*).
- d. The starting configuration of the *Robot* at the beginning of a *Match* must be the same as a *Robot* configuration inspected for compliance.
 - i. *Teams* using more than one possible *Robot* configuration at the beginning of *Matches* must tell the Inspector(s) and have the *Robot* inspected in all configurations. Rule <R3c> will apply if a *Robot* is placed in an uninspected configuration (i.e., will not be permitted to play until re-inspected, but will not be considered a "no-show").

Note: These dimensions (i.e., fit within a Starting Zone and height limit of 15") are also the maximum expansion limits during Match play.

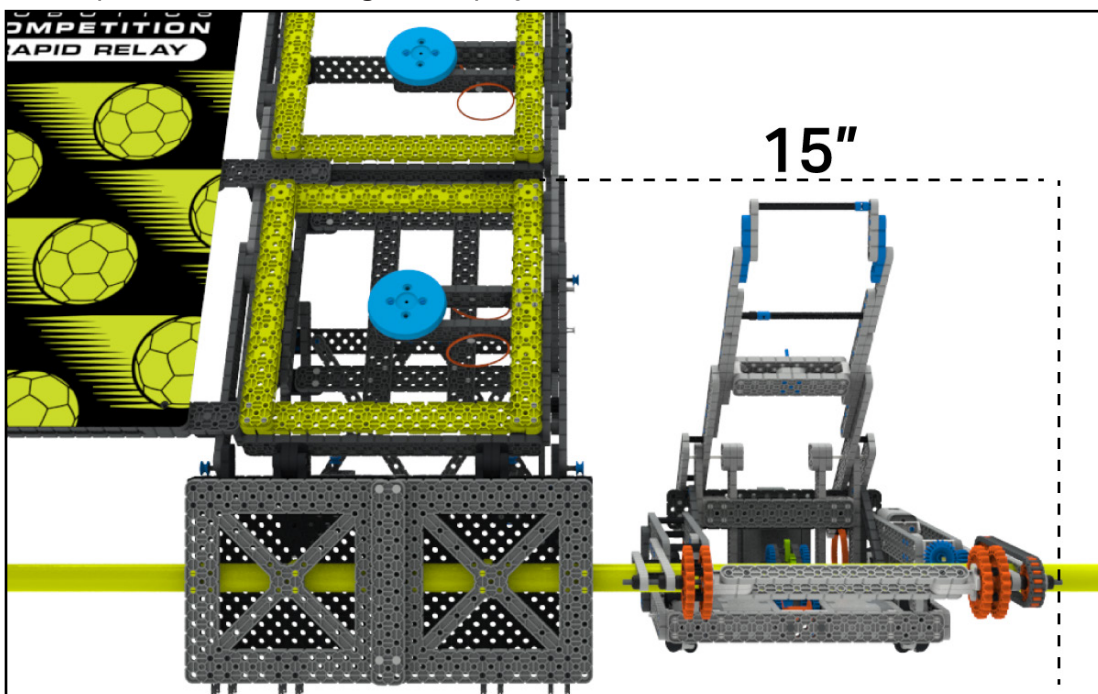

Figure R4-1: The 15" Robot height limit roughly aligns with the top of the lower set of Targets.

<R5> Prohibited items. The following types of mechanisms and components are NOT allowed:

- a. Those that could potentially damage *Field Elements* or *Balls*.
- b. Those that could potentially damage or entangle other *Robots*.
- c. Grease, oil, graphite, and/or any other lubricant or plastic additive.
- d. Tape and/or any other material that adheres to or changes a legal part, other than non-functional decorations as permitted by <R8>.

<R6> VEX IQ product line. *Robots* may be built ONLY from official *Robot* components from the VEX IQ product line, unless otherwise specifically noted within these rules.

- a. Official VEX IQ products are ONLY available from VEX Robotics. To determine whether a product is "official" or not, consult www.vexiq.com.
- b. If an Inspector or event official questions whether something is an official VEX IQ component, the *Team* will be required to provide documentation to an inspector that proves the component's source. Such documentation may include receipts, part numbers, or other printed documentation.
- c. Only VEX IQ components specifically designed for use in *Robot* construction are allowed. Using additional components outside their typical purpose is against the intent of the rule (i.e., please don't try using VEX IQ apparel, *Team* or event support materials, packaging, *Field Elements*, or other non-*Robot* products on a VEX IQ Robotics Competition *Robot*).
- d. Products from the VEX 123, VEX V5, VEX CTE, VEX EXP, Cortex, or VEXpro product lines cannot be used for *Robot* construction. However, products from the VEX V5 product line that are also cross-listed as part of the VEX IQ product line are legal. A "cross-listed" product is one which can be found in both the VEX IQ and VEX V5 sections of the VEX Robotics website.
- e. Mechanical/structural components from the VEX Robotics by HEXBUG* product line are legal for *Robot* construction. However, electrical components from the VEX Robotics by HEXBUG* product line are illegal for *Robot* construction.
- f. Mechanical/structural components from the VEX GO product line are legal for *Robot* construction. However, electrical components from the VEX GO product line are illegal for *Robot* construction.
- g. Official Robotics components from the VEX IQ product line that have been discontinued are still legal for *Robot* use. However, *Teams* must be aware of <R6b>.
- h. Functional 3D printed components, such as replicas of legal VEX IQ parts or custom designs, are not legal for *Robot* use.
- i. Additional VEX IQ products that are released during the season are legal for use, unless otherwise noted on their product pages and/or in the [VEX IQ Robotics Competition Legal Parts Appendix](#).
- j. VEX IQ Smart Cables may only be used for connecting legal electronic devices to the VEX IQ *Robot* Brain.

Note: A comprehensive list of legal parts can be found in the VEX IQ Robotics Competition Legal Parts Appendix, as mentioned above. This Appendix is updated as needed if/when new VEX IQ parts are released, and may not coincide with scheduled Game Manual updates.

* The HEXBUG brand is a registered trademark belonging to Spin Master Corp

<R7> Non-VEX IQ components. *Robots* are allowed to use the following additional “non-VEX IQ” components:

- a. Rubber bands that are identical in length and thickness to those included in the VEX IQ product line (#32, #64, #117B & #170).
- b. $\frac{1}{8}$ ” metal shafts from the VEX V5 product line.

<R8> Decorations are allowed. *Teams* may add non-functional decorations, provided that they do not affect *Robot* performance in any significant way or affect the outcome of the *Match*. These decorations must be in the spirit of the competition. Inspectors will have final say in what is considered “non-functional.” Unless otherwise specified below, non-functional decorations are governed by all standard *Robot* rules.

- a. Decorations must be in the spirit of an educational competition.
- b. To be considered “non-functional,” any decorations must be backed by legal materials that provide the same functionality. For example, a giant decal cannot be used to prevent *Balls* from falling out of the *Robot* unless it is backed by VEX IQ material. A simple way to check this is to determine if removing the decoration would impact the performance of the *Robot* in any way.
- c. The use of non-toxic paint is considered a legal non-functional decoration. However, any paint being used as an adhesive or to impact how tightly parts fit together would be classified as functional.

Teams should be mindful of any non-functional decorations which could risk “distracting” *Alliance* partner *Robots*’ Vision Sensor or other sensors.

<R9> Officially registered Team numbers must be displayed on Robot License Plates. To participate in an official VEX IQ Robotics Competition Event, a *Team* must first register on robotevents.com and receive a VEX IQ Robotics Competition *Team* Number.

This *Team* number must be legibly displayed on at least two (2) VEX IQ Robotics Competition *License Plates* on opposing sides of the *Robot*. *Teams* may choose to use the official VEX IQ Robotics Competition *License Plate* (VEX Part Number 228-7401), or may create their own custom *License Plates*.

- a. *License Plates* must fulfill all inspection rules.
- b. *License Plates* must be clearly visible at all times. For example, *License Plates* must not be in a position that would be easily obstructed by a *Robot* mechanism during standard *Match* play.
- c. Any custom-made *License Plates* used must be the same length and height as the official *License Plate* (3.5” x 1.5” [88.9mm x 38.1mm]). They must not exceed the width of the official *License Plate* (0.25” [6.35mm]).
- d. Custom-made *License Plates* are considered non-functional decorations, and must therefore meet all of the criteria listed in <R8>. Therefore, 3D printed *License Plates* are permitted within these rules.

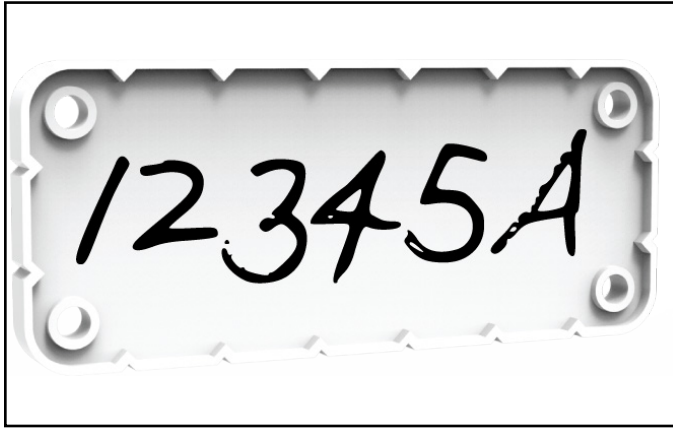

Figure R9-1: A VEX IQ Robotics Competition License Plate with a VEX IQ Robotics Competition Team Number written upon it.



Figure R9-2: An example of a legal custom License Plate.

<R10> Let it go after the Match is over. Robots must be designed to permit easy removal of Balls from their Robot without requiring that the Robot have power or remote control after the Match is over.

<R11> Robot Brain. Robots are limited to one (1) VEX IQ Robot Brain.

- a. Robot Brains, microcontrollers, and other electronic components that are part of the VEX Robotics by HEXBUG, VEX GO, VEX EXP, VEX V5, VEX 123, or VEXpro product lines are not allowed.
 - i. The Robot AA Battery Holder (228-3493) is the only exception to this rule, per <R13>.
- b. If using a first generation VEX IQ Brain, Robots must use one (1) VEX IQ 900 MHz radio, VEX IQ 2.4 GHz radio, or VEX IQ Smart Radio in conjunction with their VEX IQ Robot Brain. The VEX IQ Brain and VEX IQ Controller may not be physically connected during a Match, and may only communicate through the radio.
- c. The only legal method of driving the Robot during Teamwork Challenge Matches and Driving Skills Matches is the VEX IQ Controller.
- d. See <RSC8> and <RSC9> for more information about operating the Robot during Autonomous Coding Skills Matches.
- e. Additional Robot Brains cannot be used on the Robot (even Robot Brains that are not connected)

<R12> Motors. Robots may use up to six (6) VEX IQ Smart Motors.

- a. Additional motors cannot be used on the Robot (even motors that aren't connected).

<R13> Batteries. The only allowable sources of electrical power for a VEX IQ Robotics Competition Robot are one (1) VEX IQ Robot Battery (first or second generation) or six (6) AA batteries via the Robot AA Battery Holder (228-3493).

- a. Additional batteries cannot be used on the *Robot* (even batteries that aren't connected).
- b. *Teams* are permitted to have an external power source (such as a rechargeable battery pack) plugged into their VEX IQ Controller during a *Match*, provided that this power source is connected safely and does not violate any other rules (such as <G8>).

Note: Although it is legal, the Robot AA Battery Holder (228-3493) is not recommended for use in the VEX IQ Robotics Competition.

<R14> Firmware. *Teams* must use VEXos version 2.2.1 or newer on Gen1 Brains, or VEXos version 1.0.8 or newer on Gen2 Brains. The latest firmware can be found at <https://link.vex.com/firmware>. Custom firmware modifications are not permitted.

- a. The minimum VEXos version requirement is subject to change over the course of the season.
- b. When the minimum version is updated, *Teams* have a two week (14 calendar days) grace period from the time the minimum version is changed to update their firmware to the latest minimum version.
- c. VEX reserves the right to deem any firmware update critical, and remove the allowable grace period.

<R15> Modifications of parts. Parts may NOT be modified unless specifically listed as an exception in this rule. Examples of modifications include, but are not limited to, bending, cutting, sanding, gluing, or melting. The following exceptions are legal:

- a. Cutting metal VEX IQ or VEX V5 shafts to custom lengths.
- b. Bending parts which are intended to be flexible, such as string, rubber bands, or thin plastic sheets.
- c. Cutting VEX IQ pneumatic tubing to custom lengths.

<R16> Pneumatics. *Robots* using parts from the VEX IQ Pneumatics Kit (228-8795) must satisfy the following criteria:

- a. No more than two (2) Air Tanks, including any that aren't connected.
- b. No more than (1) Air Pump, including any that aren't connected.
- c. No additional parts that are not included in the VEX IQ Pneumatics Kit (e.g., unofficial tubing or fittings).

Note: There is no limit on the number of Pneumatic Cylinders or Pneumatic Solenoids that may be used, provided that no other rules are violated. There are no restrictions on running the Air Pump prior to (or during) Matches.

The intent of <R16a> is to limit *Robots* to the air pressure stored in two Air Tanks, as well as the normal working air pressure contained in any Pneumatic Cylinders and tubing on the *Robot*. *Teams* may not use other elements for the purposes of storing or generating air pressure.

Using Pneumatic Cylinders or additional tubing solely for additional air storage is in *Violation* of the spirit of this rule. Similarly, using Pneumatic Cylinders and/or tubing without an actual pneumatic system (e.g., Air Tanks and/or a Air Pump) is also in *Violation* of the spirit of this rule.

<R17> There is a difference between accidentally and willfully violating a Robot rule. Any violation of *Robot* rules, accidental or intentional, will result in a *Team* being unable to play until they pass inspection (per <R3d>).

However, *Teams* who intentionally and/or knowingly circumvent or violate rules to gain an advantage over their fellow competitors are in violation of the spirit and ethos of the competition. Any *Violation* of this sort should be considered a violation of <G1> and/or the REC Foundation Code of Conduct. A *Team* that circumvents a *Robot* rule for a competitive advantage should receive an immediate *Disqualification* for the current *Match* and be reported to the *Event Partner* for discussion with the REC Foundation Regional Support Manager. As a result of that discussion, the *Team* may be *Disqualified* from the event. The *Violation* should also be reported to the REC Foundation Rules and Conduct Committee following the event.

Section 4

The Event

Description

The VEX IQ Robotics Competition encompasses both the *Teamwork Challenge* and the *Robot Skills Challenge*. This section determines how the *Teamwork Challenge* and *Robot Skills Challenge* are to be played at a given event. For information about the requirements for tournaments that qualify teams to championship events, [visit this article in the REC Library](#).

Awards may be given to top *Teams* in each format, as applicable. Awards may also be given for overall performance in the judged criteria. Please review the [Guide to Judging: Awards article in the REC Library](#) for more details.

Tournament Definitions

Event Partner – The volunteer VEX IQ Robotics Competition tournament coordinator who serves as an overall manager for the volunteers, venue, event materials, and all other event considerations. *Event Partners* serve as the official liaison between the REC Foundation, the event volunteers, and event attendees.

Finals Match – A *Teamwork Match* used to determine the *Teamwork Challenge* champions.

Head Referee – A certified impartial volunteer responsible for enforcing the rules in this manual as written. *Head Referees* are the only people who may discuss ruling interpretations or scoring questions with *Teams* at an event. Large events (e.g., Signature Events, World Championships, etc.) might include multiple *Head Referees* at the *Event Partner's* discretion.

Match Stop Time – The time remaining (i.e., displayed on the timer or audience display) in a tiebreaker *Finals Match* when an *Alliance* ends the *Match* early by placing their controllers on the ground. The *Match Stop Time* is rounded down to the nearest even number. For example, if controllers are set down when the displayed time is 13 seconds, the *Match Stop Time* is recorded as 12 seconds. If an *Alliance* does not finish the *Match* early, they receive a default *Match Stop Time* of 0 seconds.

Practice Match – A non-scored *Match* used to provide time for *Teams* to get acquainted with the official playing *Field*.

Qualification Match – A *Teamwork Challenge Match* used to determine the event rankings.

Robot Skills Challenge – A portion of the VEX IQ Robotics Competition. The *Robot Skills Challenge* consists of *Driving Skills Matches* and *Autonomous Coding Skills Matches* as described in the General Definitions.

Scorekeeper Referee – An impartial volunteer responsible for tallying scores at the end of a *Match*. *Scorekeeper Referees* do not make ruling interpretations, and should redirect any *Team* questions regarding rules or scores to the *Head Referee*.

Teamwork Challenge – A portion of the VEX IQ Robotics Competition. The *Teamwork Challenge* consists of *Teamwork Challenge Matches*. The *Teamwork Challenge* includes *Qualification Matches* and *Finals Matches*, and may include *Practice Matches*.

Tournament Rules

<T1> The Head Referee has ultimate and final authority on all gameplay ruling decisions during the competition.

- a. *Scorekeeper Referees* score the *Match*, and may serve as observers or advisers for the *Head Referee*, but may not determine any rules or infractions directly.
- b. When issuing a *Disqualification* or *Violation* to a *Team*, the *Head Referee* should attempt to notify the *Team* as the *Violation* occurs, and after the *Match* must provide the rule number of the specific rule that has been Violated and record the *Violation* in the Match Anomaly Log.
- c. *Major Violations* of the REC Foundation Code of Conduct and other rules related to the Code of Conduct require additional escalation beyond the *Head Referee's* initial ruling, including (but not limited to) investigation by REC Foundation representatives. Rules <S1>, <S2>, <G1>, <G2>, <G4>, and <R17> are the rules for which this escalation may be required.
- d. *Event Partners* may not overrule a *Head Referee's* decision.
- e. Every *Qualification Match* and *Finals Match* must be watched by a certified *Head Referee*. *Head Referees* may only watch one *Match* at a time; if multiple *Matches* are happening simultaneously on separate fields, each field must have its own *Head Referee*.

Note from the VEX GDC: The rules contained in this Game Manual are written to be enforced by human *Head Referees*. Many rules have "black-and-white" criteria that can be easily checked. However, some rulings will rely on a judgment call from this human *Head Referee*. In these cases, *Head Referees* will make their calls based on what they and the *Scorekeeper Referees* saw, what guidance is provided by their official support materials (the Game Manual and the Q&A), and most crucially, the context of the *Match* in question.

The VEX IQ Robotics Competition does not have video replay, our *Fields* do not have absolute sensors to count scores, and most events do not have the resources for an extensive review conference between each *Match*.

When an ambiguous rule results in a controversial call, there is a natural instinct to wonder what the "right" ruling "should have been," or what the GDC "would have ruled." This is ultimately an irrelevant question; our answer is that when a rule specifies "*Head Referee's* discretion" (or similar), then the "right" call is the one made by the *Head Referee* in the moment. The VEX GDC designs games, and writes rules, with this expectation (constraint) in mind.

<T2> Head Referees must be qualified. VEX IQ *Head Referees* must have the following qualifications:

- a. Be at least 16 years of age.
- b. Be approved by the *Event Partner*.
- c. Be an REC Foundation Certified VIQRC *Head Referee* for the current season. Visit [the RECF Library](#) for more details.

Note: Scorekeeper Referees must be at least 15 years of age, and must be approved by the Event Partner.

<T3> The Drive Team Members are permitted to immediately appeal the Head Referee's ruling.

If *Drive Team Members* wish to dispute a score or ruling, they must stay in the *Driver Station* until the *Head Referee* talks with them. The *Head Referee* may choose to meet with the *Drive Team Members* at another location and/or at a later time so that the *Head Referee* has time to reference materials or resources to help with the decision. Once the *Head Referee* announces that their decision has been made final, the issue is over and no more appeals may be made (see rule <T1>).

- a. *Head Referees* may not review any photo or video *Match* recordings when determining a score or ruling.
- b. *Head Referees* are the only individuals permitted to explain a rule, *Disqualification*, or *Violation* to the *Teams*. *Teams* should never consult other field personnel, including *Scorekeeper Referees*, regarding a ruling clarification.

Communication and conflict resolution skills are an important life skill for *Students* to practice and learn. In VEX IQ Robotics Competitions, we expect *Students* to practice proper conflict resolution using the proper chain of command. *Violations* of this rule may be considered a *Violation* of <G1> and/or the Code of Conduct.

Some events may choose to utilize a "question box" or other designated location for discussions with *Head Referees*. Offering a "question box" is within the discretion of the *Event Partner* and/or *Head Referee*, and may act as an alternate option for asking *Drive Team Members* to remain in the *Driver Station* (although all other aspects of this rule apply).

However, by using this alternate location, *Drive Team Members* acknowledge that they are forfeiting the opportunity to use any contextual information involving the specific state of the *Field* at the end of the *Match*. For example, it is impossible to appeal whether a game element was *Scored* or not if the *Field* has already been reset. If this information is pertinent to the appeal, *Drive Team Members* should still remain in the *Driver Station*, and relocate to the "question box" once the *Head Referee* has been made aware of the concern and/or any relevant context.

<T4> The Event Partner has ultimate authority regarding all non-gameplay decisions during an event. The Game Manual is intended to provide a set of rules for successfully playing VIQRC Rapid Relay; it is not intended to be an exhaustive compilation of guidelines for running a VEX IQ Robotics Competition event. Rules such as, but not limited to, the following examples are at the discretion of the *Event Partner* and should be treated with the same respect as the Game Manual:

- Venue access
- Pit spaces and pit access
- Health and safety
- *Team* registration and/or competition eligibility
- *Team* conduct away from competition fields

This rule exists alongside <G1>, <S1>, and <G3>. Even though there isn't a rule that says "do not steal from the concession stand," it would still be within an *Event Partner's* authority to remove a thief from the competition.

<T5> Be at your match on time. If no member of a *Team* is present in the *Driver Station* at the start of a *Match*, that *Team* is considered a "no show" and will receive zero (0) points. The other *Team* in the *Alliance* will still play and receive points for the *Match*.

<T6> Robots at the field must be ready to play. If a *Team* brings their *Robot* to the *Field*, it must be prepared to play (i.e., batteries charged, sized within the starting size constraint, etc.)

- a. *Robots* must be placed on the field promptly. Repeated failure to do so could result in a *Violation* of <G1> and/or removal of the *Robot* from the current *Match* at the *Head Referee's* discretion.

The definition of the word "promptly" is at the discretion of the *Event Partner* and *Head Referee*, who will consider event schedule, previous warnings or delays, etc. As a general guideline, five seconds to check *Robot* alignment would be acceptable, but five minutes to assemble multiple parts together would not.

<T7> Match Replays are allowed, but rare. *Match* replays (i.e., playing a *Match* over again from its start) are at the discretion of the *Event Partner* and *Head Referee*, and will only be issued in the most extreme circumstances. Some examples that may warrant a *Match* replay are as follows:

- a. *Score Affecting* "Field fault" issues.
 - i. *Switches* not being reset before the *Match* starts.
 - ii. *Field Elements* detaching or moving beyond normal tolerances, not as a result of *Robot* interactions.
- b. *Score Affecting* game rule issues.
 - i. A *Field* is reset before the score is determined.

Significant Q&As:

- [2094](#) - The list of replay examples is not comprehensive

<T8> Disqualifications. A *Team* that is issued a *Disqualification* in a *Qualification Match* receives zero (0) points for the *Match*. The other *Team* on their *Alliance* will still receive points for the *Match*.

- In *Finals Matches*, *Disqualifications* apply to the whole *Alliance*, not just one *Team*. An *Alliance* that receives a *Disqualification* in a *Finals Match* will receive zero (0) points.
- A *Team* that receives a *Disqualification* in a *Robot Skills Match* will receive a score of zero (0).

<T9> Timeouts. There are no timeouts in VEX IQ tournaments.

<T10> Be prepared for minor field variance. *Field Element* tolerances may vary from nominal by up to ± 0.5 " [25.4mm], unless otherwise specified. *Ball* weights may vary from nominal by up to ± 5 grams. *Teams* are encouraged to design their *Robots* accordingly. Please make sure to check Appendix A for more specific nominal dimensions and tolerances.

<T11> Fields and Field Elements may be repaired at the Event Partner's discretion. All competition fields and other *Field Elements* at an event must be set up in accordance with the specifications in Appendix A and/or other applicable support materials. Minor aesthetic customizations or repairs are permitted, provided that they do not impact gameplay (see <T4>).

Examples of permissible modifications include, but are not limited to:

- Replacing a damaged or missing VEX IQ *Field* component with an identical part of any color.
- Elevating the playing field off of the Floor (common heights are 10" to 24" [254mm to 609.6mm]).
- Using off-the-shelf PVC to replace a damaged or missing *Pickup Zone* pipe.
- Repairing a *Ball* that has been ripped open by sewing it back together.

Significant Q&As:

- [2019](#) - EPs should not decorate balls to make them easier to distinguish

<T12> Teamwork Matches. During *Teamwork Challenge Matches*, two (2) *Teams* form an *Alliance* that will play on the *Field*.

- Qualification Match Alliances* are randomly selected.
- Finals Match Alliances* are assigned as follows:
 - The first and second ranked *Teams* form an *Alliance*.
 - The third and fourth ranked *Teams* form an *Alliance*.
 - And so on, until all *Teams* participating in *Finals Matches* have formed an *Alliance*.

<T13> Ending a Match early. If an *Alliance* wants to end a *Qualification Match* or a *Finals Match* early, both *Teams* must signal the referee by ceasing all *Robot* motion and placing their controllers on the ground. The referee will then signal to the *Teams* that the *Match* is over and will begin to tally the score. If the *Match* is a tiebreaker *Finals Match*, then the *Match Stop Time* will also be recorded.

<T14> Practice Matches may be played at some events, but are not required. If *Practice Matches* are run, every effort will be made to equalize practice time for all *Teams*.

<T15> Qualification Matches will occur according to the official match schedule. This schedule will indicate *Alliance* partners, *Qualification Match* times, and, if the event has multiple *Fields*, which *Field* each *Qualification Match* will be played on.

Note: The official Match schedule is subject to changes at the Event Partner's discretion.

<T16> Each Team will be scheduled Qualification Matches as follows.

- a. When in a tournament, the tournament must have a minimum of six (6) *Qualification Matches* per *Team* at local qualifying events and eight (8) for a Championship event.
- b. When in a league, there must be at least three (3) league ranking sessions, with at least one (1) week between sessions. Each session must have a minimum of two (2) *Qualification Matches* per *Team*. The suggested number of *Qualification Matches* per *Team* for a standard league ranking session is four (4). *Event Partners* may choose to have *Qualification Matches* as part of their league finals session.

<T17> Teams are ranked by their average Qualification Match scores.

- a. When in a tournament, every *Team* will be ranked based on the same number of *Qualification Matches*.
 - i. For tournaments that have more than one (1) division, *Teams* will be ranked among all *Teams* in their specific division. Each division will have its own set of *Finals Matches*. The winners of each division will then have an overall event Finals. Any multi-division event must be approved by the REC Foundation Regional Support Manager prior to the event, and divisions must be assigned in alternating sequential order by *Team* number.
- b. When in a league, every *Team* will be ranked based on the number of *Matches* played. *Teams* that participate in less than 60% of the total *Matches* available will be ranked below *Teams* that participate in at least 60% of the total *Matches* available (e.g., if the league offers 3 ranking sessions with 4 *Qualification Matches* per *Team*, *Teams* that participate in 8 or more *Matches* will be ranked higher than *Teams* who participate in 7 or fewer *Matches*). Being a no-show to a *Match* that a *Team* is scheduled in still constitutes participation for these calculations.
- c. A certain number of a *Team's* lowest *Qualification Match* scores will be excluded from the rankings based on the quantity of *Qualification Matches* each *Team* plays. Excluded scores do not affect participation for leagues.

Number of Qualification Matches per Team	Number of excluded Match scores
4-7	1
8-11	2
12-15	3
16+	4

- d. In some cases, a *Team* will be assigned to play an additional *Qualification Match*. The extra *Match* will be identified on the *Match Schedule* with an asterisk and will not impact the *Team's* ranking (or participation for leagues). *Teams* are reminded that <G1> is always in effect and *Teams* are expected to behave as if the additional *Qualification Match* counted.
- e. Ties in *Team* ranking are broken by:
 - i. Removing the *Team's* lowest score and comparing the new average score.
 - ii. Removing the *Team's* next lowest score and comparing the new average score (on through all scores).
 - iii. If the *Teams* are still tied, the *Teams* will be sorted by random electronic draw.

<T18> Teams playing in Finals Matches. The number of *Finals Matches*, and therefore the number of *Teams* who will participate in *Finals Matches*, is determined by the *Event Partner*. Events must have a minimum of five (5) *Finals Matches* if there are ten (10) or more *Teams* in attendance.

<T19> Finals Match Schedule. *Finals Matches* are played sequentially, starting with the lowest-ranked *Alliance*. Each *Alliance* will participate in one (1) *Finals Match*. The *Alliance* with the highest *Finals Match* score is the *Teamwork Challenge* champion.

- a. *Alliances* are ranked by their *Finals Match* score. The highest-scoring *Alliance* is in first place, the second-highest-scoring *Alliance* is in second place, etc.
- b. Ties for first place will result in a series of tiebreaker *Finals Matches*, starting with the lower-seeded *Alliance*. The *Alliance* with the highest tiebreaker *Finals Match* score will be declared the *Teamwork Challenge* champion.
 - i. If the tiebreaker *Finals Match* scores are tied, the *Alliance* with the higher *Match Stop Time* will be declared the winner.
 - ii. If the *Match Stop Time* is also tied, a second series of tiebreaker *Finals Matches* will be played. If this second series of tiebreaker *Finals Matches* is also tied, then the higher-seeded *Alliance* will be declared the winner.
 - iii. If there is a tie for a place other than first, the higher-seeded *Alliance* will receive the higher rank.

Example 1: *Alliance 6* and *Alliance 3* are tied for first place. During the tiebreaker *Finals Match*, *Alliance 6* scores 13 points and has a *Match Stop Time* of 12 seconds. *Alliance 3* scores 13 points and has a *Match Stop Time* of 10 seconds. *Alliance 6* is the *Teamwork Challenge* winner.

Example 2: *Alliance 4* and *Alliance 5* are tied for third place. *Alliance 4* is the third place winner and *Alliance 5* is the fourth place winner. In this way, the lower ranked *Alliance* must "overcome" the higher ranked *Alliance* in order to become the *Teamwork Challenge* champion.

Section 5 - Robot Skills

Overview

In this challenge, *Teams* will compete in sixty-second (1:00) *Matches* in an effort to score as many points as possible. These *Matches* consist of *Driving Skills Matches*, which are entirely driver controlled, and *Autonomous Coding Skills Matches*, which are autonomous with limited human interaction. *Teams* will be ranked based on their combined score in the two types of *Robot Skills Matches*.

Robot Skills Challenge Definitions

All definitions from "The Game" section of the manual apply to the Robot Skills Challenge, unless otherwise specified.

Driving Skills Match – A *Driving Skills Match* consists of a sixty-second (1:00) *Driver Controlled Period*. There is no *Autonomous Period*. *Teams* can elect to end a *Driving Skills Match* early if they wish to record a *Skills Stop Time*.

Autonomous Coding Skills Match – An *Autonomous Coding Skills Match* consists of a sixty-second (1:00) *Autonomous Period*. There is no *Driver Controlled Period*. *Teams* can elect to end an *Autonomous Coding Skills Match* early if they wish to record a *Skills Stop Time*.

Robot Skills Match – A *Driving Skills Match* or *Autonomous Coding Skills Match*.

Skills Stop Time – The time remaining in a *Robot Skills Match* when a *Team* ends the *Match* early.

- a. If a *Team* does not end the *Match* early, they receive a default *Skills Stop Time* of 0.
- b. The moment when the *Match* ends early is defined as the moment when the *Robot* and *Balls* have come to a rest and the *Driver* provides the agreed upon visual and audio signal to the Referee. See <RSC10> for more details.
- c. If a Tournament Manager display is being used for field control, then the *Skills Stop Time* is the time shown on the display when the *Match* is ended early (i.e., in 1-second increments).
- d. If a manual timer is being used that counts down to 0 with greater accuracy than 1-second increments, then the time shown on the timer should be rounded up to the nearest second. For example, if the *Robot* is disabled and the timer shows 25.2 seconds, then the *Skills Stop Time* should be recorded as 26.

Robot Skills Challenge Rules

<RSC1> Standard rules apply in most cases. All rules from previous sections apply to the *Robot Skills Matches*, unless otherwise specified.

<RSC2> Scoring Robot Skills Matches. The point value per *Goal* is determined at the end of the *Match*, based on how many *Switches* have been *Cleared* by the end of that *Match*. See the following table for details.

Each Cleared Switch	1 Point
Each Goal - 1 Cleared Switch	4 Points
Each Goal - 2 Cleared Switches	8 Points
Each Goal - 3 Cleared Switches	10 Points
Each Goal - 4 Cleared Switches	12 Points

<RSC3> Robot Skills Field setup. The *Field* is set up the same as a *Teamwork Challenge Match* (i.e., per <SG1>), with the following modifications:

- In addition to the *Preload*, *Teams* may place a second *Ball* anywhere in *Starting Zone 1* (i.e., the one closest to the *Pickup Zone*) to begin the *Match*.
- Robots* must begin in *Starting Zone 2* (i.e., the one closest to the *Loading Station*).

<RSC4> Loading differences. All criteria listed in <SG4> and <SG5> apply as written (e.g., no more than two *Balls* on the *Field*, *Robots* may not be in the *Load Zone* during *Loading*, etc.). However, *Rapid Loading* is modified as follows:

- Starting Zone 2* (i.e., the one closest to the *Loading Station*) is the only *Starting Zone* that may be used for *Rapid Loading*.
- In *Driving Skills Matches*, the *Rapid Load Period* is defined as any time after the mid-*Match Driver* switch takes place.
- In *Autonomous Coding Skills Matches*, the entire *Match* is considered a *Rapid Load Period* (i.e., there is no requirement to use the *Loading Station*).
 - Clause "D" of <SG3> does not apply in *Autonomous Coding Skills Matches*.

Note: In both Driving Skills Matches and Autonomous Coding Skills Matches, any Driver who is not currently operating the Robot may also serve as a Loader (i.e., a Team may have two Loaders at any given time).

Significant Q&As:

- [2021](#) - All 3 Drive Team Members may serve as Loaders in Autonomous Coding Skills Matches

<RSC5> Skills Ranking at events. For each *Robot Skills Match*, *Teams* are awarded a score based on the skills rules and skills scoring rules. *Teams* will be ranked based on the following scores and tiebreakers:

- a. Sum of highest *Autonomous Coding Skills Match* score and highest *Driving Skills Match* Score.
- b. Highest *Autonomous Coding Skills Match* score.
- c. Second-highest *Autonomous Coding Skills Match* score.
- d. Second-highest *Driving Skills Match* score.
- e. Highest sum of *Skills Stop Times* from a *Team's* highest *Autonomous Coding Skills Match* and highest *Driving Skills Match* (i.e., the *Matches* in point a).
- f. Highest *Skills Stop Time* from a *Team's* highest *Autonomous Coding Skills Match* (i.e., the *Match* in point b).
- g. Third-highest *Autonomous Coding Skills Match* score.
- h. Third-highest *Driving Skills Match* score.
- i. If the tie cannot be broken after all above criteria (i.e., both *Teams* have the exact same scores and *Skills Stop Times* for each *Autonomous Coding Skills Match* and *Driving Skills Match*), then the following ordered criteria will be used to determine which team had the "best" *Autonomous Coding Skills Match*:
 - i. Points for *Cleared Switches*
 - ii. Points for *Goals Scored*
- j. If the tie still cannot be broken, the same process in the step above will be applied to the *Teams'* highest *Driving Skills Matches*.
- k. If the tie still isn't broken, the *Event Partner* may choose to allow *Teams* to have one more deciding *Match*, or both *Teams* may be declared the winner.

<RSC6> Skills Rankings Globally. *Teams* are ranked based on their *Robot Skills Match* scores globally using the following tiebreakers:

- a. Highest *Robot Skills* score (combined *Autonomous Coding Skills Match* and *Driving Skills Match* from a single event).
- b. Highest *Autonomous Coding Skills Match* score (from any event).
- c. Highest sum of *Skills Stop Times* from the *Robot Skills Matches* used for point a.
- d. Highest *Skills Stop Time* from the *Autonomous Coding Skills Match* used for point b.
- e. Highest *Driving Skills Match* score (from any event).
- f. Highest *Skills Stop Time* from the *Driving Skills Match* score used in point e.
- g. Earliest posting of the highest *Autonomous Coding Skills Match* score.
 - i. The first *Team* to post a score ranks ahead of other *Teams* that post the same score at a later time, all else being equal.

- h. Earliest posting of the highest *Driving Skills Match* score.
 - i. The first *Team* to post a score ranks ahead of other *Teams* that post the same score at a later time, all else being equal.

<RSC7> Skills Match Schedule. *Teams* play *Robot Skills Matches* on a first-come, first-served basis. Each *Team* will get the opportunity to play exactly three (3) *Driving Skills Matches* and three (3) *Autonomous Coding Skills Matches*.

Teams should review the event agenda and their *Match* schedule to determine when the best possible time is to complete their *Robot Skills Matches*. If the Robot Skills Challenge area closes before a *Team* has completed all six (6) *Robot Skills Matches*, but it is determined that there was adequate time given, then the *Team* will automatically forfeit those unused *Matches*.

Further details regarding Skills-Only Event logistics can be found in the [REC Foundation Qualifying Criteria document](#).

<RSC8> Handling Robots during an Autonomous Coding Skills Match. A *Team* may handle their *Robot* as many times as desired during an *Autonomous Coding Skills Match*.

- a. Upon handling the *Robot*, it must be immediately brought back to *Starting Zone 2*.
 - i. *Drive Team Members* may reset or adjust the *Robot* as desired from this position, including pressing buttons on the Robot Brain or activating sensors.
 - ii. Any *Balls* being controlled by the *Robot* while being handled must be removed from the *Field*, and can be returned through the *Loading Station* or *Rapid Loaded* as appropriate based on the *Match* type and *Match* timer.
 - iii. As described in rule <S1>, *Students* cannot step into the *Field* at any time during a *Match*. If the *Drive Team Members* cannot reach the *Robot* due to the *Robot* being in the center of the *Field*, they may ask the *Head Referee* to pick up the *Robot* and hand it to the *Drive Team Members* for placement according to the conditions above."
- b. During an *Autonomous Coding Skills Match*, *Drivers* may move freely around the *Field*, and are not restricted to the *Driver Station* when not handling their *Robot*.
 - i. The rest of <G8>, which states that *Drive Team Members* are not allowed to use any communication devices during their *Match*, still applies.
 - ii. An intent of this exception is to permit *Drivers* who wish to "stage" *Robot* handling during an *Autonomous Coding Skills Match* to do so without excessive running back and forth to the *Driver Station*.

This rule is an explicit exception to rule <G9> and the Violation Note for <G10>, and may be used as part of a *Team's* strategy for *Autonomous Coding Skills Matches*.

Driving Skills Matches are still governed by <G9> and the Violation Note for <G10>, especially for strategic violations.

<RSC9> Starting an Autonomous Coding Skills Match. *Drivers must start a Robot's Autonomous Coding Skills Match routine by pressing a button on the Robot Brain or manually activating a sensor. Because there is no VEX IQ Controller hand-off, only one (1) Driver is required for an Autonomous Coding Skills Match (though Teams may still have two (2) if desired).*

- a. Pre-match sensor calibration is considered part of the standard pre-Match setup time (i.e., the time when the Team would typically be turning on the Robot, moving any mechanisms to their desired legal start position, etc.).
- b. Pressing a button on the VEX IQ Controller to begin the routine is not permitted. To avoid any confusion, Teams are advised not to bring controllers to Autonomous Coding Skills Matches.

In accordance with <T6>, Teams should be mindful of event schedules and set their Robot up as promptly as possible. The definition of "prompt" is at the discretion of the Event Partner and Head Referee, and could depend on things like how much time is left for the Skills Challenge field(s) to be open, how many Teams are waiting in line, etc. As a general guideline, three seconds to calibrate a Gyro Sensor would be acceptable, but three minutes to debug a program would not.

<RSC10> Skills Stop Time. *If a Team wishes to end their Robot Skills Match early, they may elect to record a Skills Stop Time. This is used as a tiebreaker for Robot Skills Challenge rankings. A Skills Stop Time does not affect a Team's score for a given Robot Skills Match. Drivers and field staff must agree prior to the Match on the signal that will be used to end the Match early.*

- a. As noted in the definition of Skills Stop Time, the moment when the Match ends early is defined as the moment when the Robot and Balls have come to a rest and the Driver provides the agreed upon visual and audio signal to the Scorekeeper Referee.
- b. Teams who intend to attempt a Skills Stop Time must "opt-in" by verbally confirming with the Scorekeeper Referee prior to the Robot Skills Match. If no notification is given prior to the start of the Match, then the Team forfeits their option to record a Skills Stop Time for that Match.
- c. This conversation should include informing the Scorekeeper Referee which Driver will signal the stop. The Match may only be ended early by a Driver for that Match.
- d. The agreed-upon signal to stop the Match must be both verbal and visual, such as Drivers crossing their arms in an "X" or placing their VEX IQ Controller on the ground.
- e. It is recommended that the Driver also provides a verbal notice that they are approaching their Skills Stop Time, such as counting out "3-2-1-stop."
- f. If a Team runs multiple Robot Skills Matches in a row, they must reconfirm their Skills Stop Time choice with the Scorekeeper Referee prior to each Match.
- g. Any questions regarding a Skills Stop Time should be reviewed and settled immediately following the Match. <T1> and <T3> apply to Robot Skills Matches.

<RSC11> Robot Skills at League Events. At league events in which *Teams* may submit Robot Skills Challenge scores across multiple sessions, the Robot Skills scores (combined highest *Autonomous Coding Skills Match* and *Driving Skills Match* scores) used for rankings will be calculated from *Matches* within the same session.

For example, consider the following scores for a hypothetical *Team* across two league event sessions:

	Autonomous Coding Skills Match	Driving Skills Match	Robot Skills Score
Session 1	100	100	200
Session 2	150	40	190

This *Team* would have a Robot Skills score of 200 for this event’s rankings, and their scores from Session 1 would be used for the Event and Global tiebreakers listed in the above two sections.

Appendix A - Field Overview

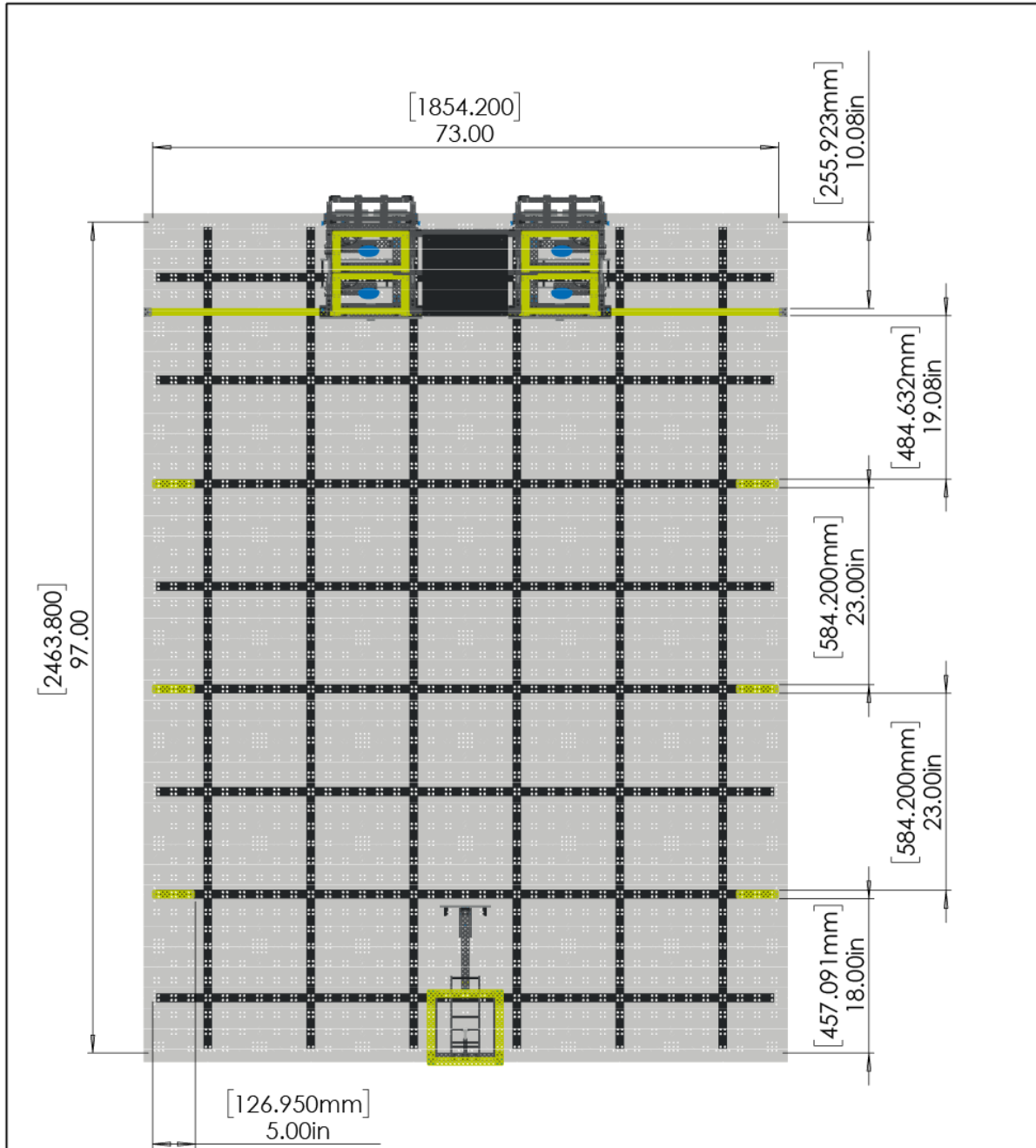

	Description Appendix A- Zones	
	Dwg No	
	Competition 2024-2025 VQRC Rapid Relay	Sheet 1 of 1
	Release 5/2/2024	ALL DIMENSIONS ARE IN INCHES [MILLIMETERS].

WWW.VEXROBOTICS.COM

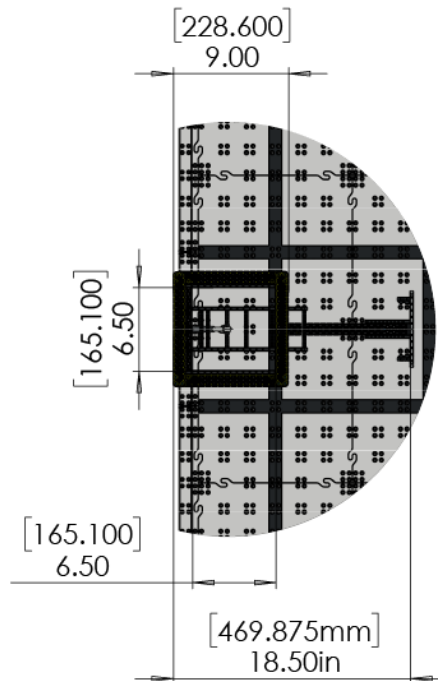
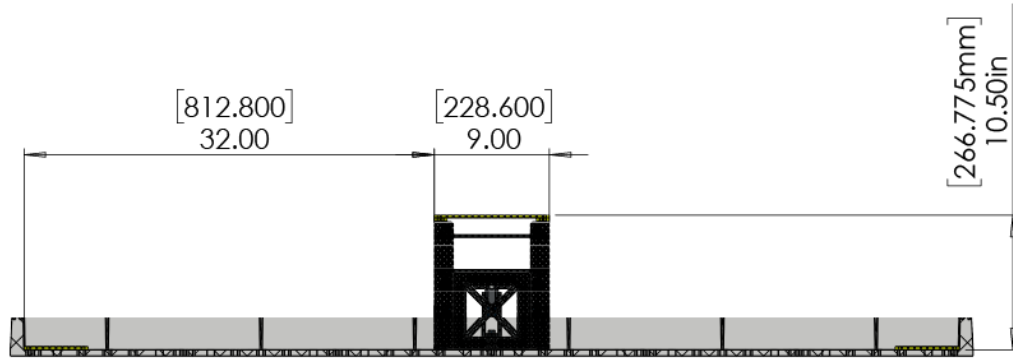

	Description Appendix A- Loading Station	
	Dwg No	
	Competition 2024-2025 VIQRC Rapid Relay	Sheet 1 of 1
	Release 5/2/2024	ALL DIMENSIONS ARE IN INCHES [MILLIMETERS].

www.VEXROBOTICS.COM

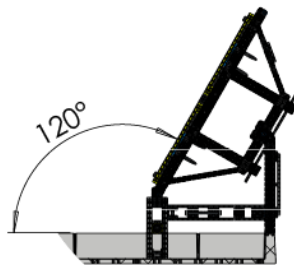
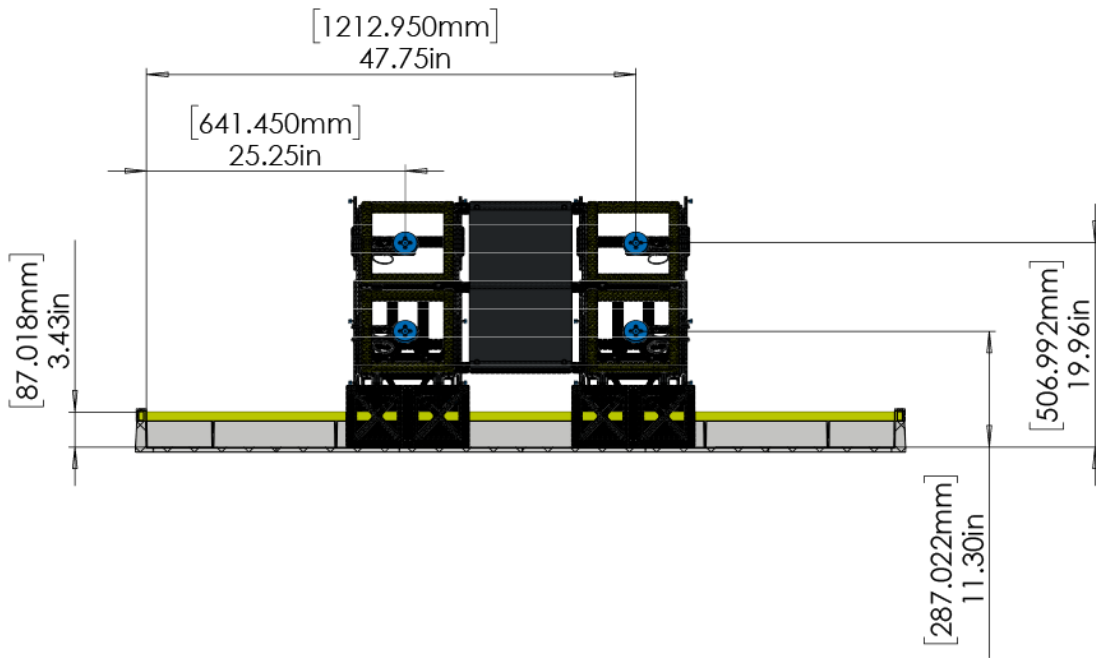

VEX IQ	Description Appendix A- Goal Wall	
	Dwg No	
	Competition 2024-2025 VIQRC Rapid Relay	Sheet 1 of 1
	Release 5/2/2024	ALL DIMENSIONS ARE IN INCHES [MILLIMETERS].

www.VEXROBOTICS.COM

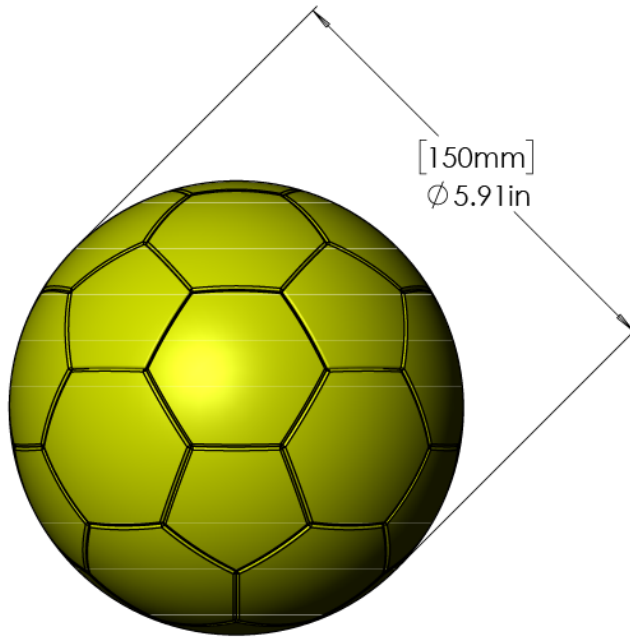

Approximate Weight:
120g

	Description Appendix A- Ball	
	Dwg No	
	Competition 2024-2025 VIQRC Rapid Relay	Sheet 1 of 1
	Release 5/2/2024	ALL DIMENSIONS ARE IN INCHES [MILLIMETERS]. www.VEXROBOTICS.COM

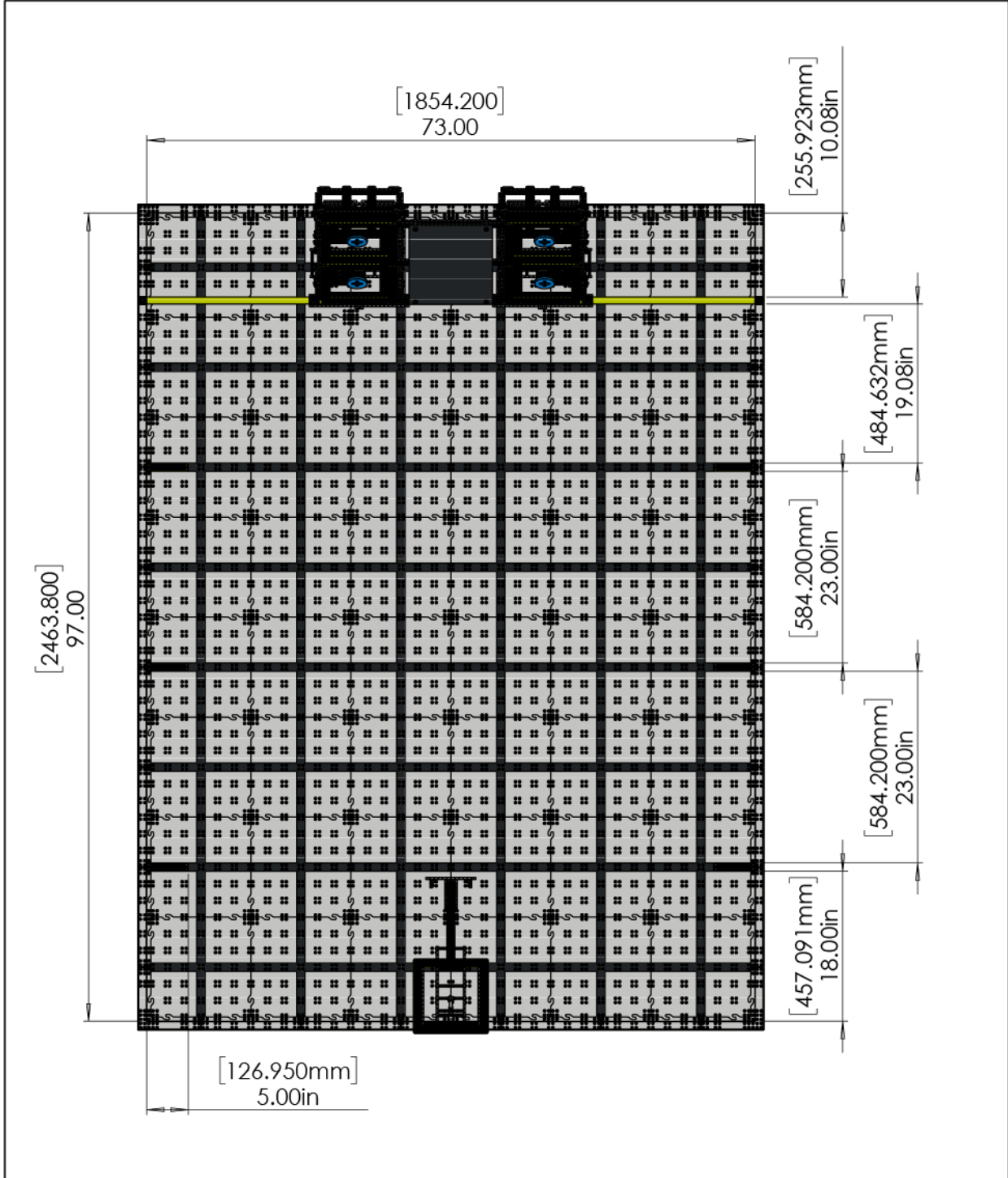

	Description Appendix A- Zones	
	Dwg No	
	Competition 2024-2025 VIQRC Rapid Relay	Sheet 1 of 1
	Release 5/2/2024	ALL DIMENSIONS ARE IN INCHES [MILLIMETERS].

www.VEXROBOTICS.COM

Appendix B

Student-Friendly Appendix

Using this Appendix

Hi Kids!

Welcome to the VEX IQ Robotics Competition! We are so happy that you want to be on a *Team*! Each year, there is a new game with a new set of rules, and playing fairly by those rules is very important. We know that learning new things can be hard, and that the “big game manual” can be kind of a lot. So, we’re here to help!

You and your teammates can start here and work together to learn about the important parts of the field, how to earn points, study basic rules, and see different ways to play the game.

But these are only some of the rules of this year’s game, and you will need to know them all! So after you understand everything here, and before you go to your first event, head over to the [official game manual](#) to make sure you understand all of the rules.

Good luck this season, and we hope that you have fun, make lots of friends, and work together to build your best Robot ever!

Your Robotics friends,
The VEX Robotics Competition Game Design Committee

Hi Grown Ups!

This unofficial version of the VEX IQ Robotics Competition manual is a print-friendly resource for you and your *Teams* to help introduce students to this year’s game, Rapid Relay.

This is NOT a replacement for reading the manual in its entirety; we encourage you to use this Appendix to support team members who may be overwhelmed by the full game manual, and use it to aid in building a basic understanding of the game. *Students* can use this appendix to learn game-specific terminology (oftentimes capitalized like a proper noun), understand the basics of scoring, and create strategies.

Once *Students* are comfortable with this appendix and the rules outlined here, you should transition them to reading and using the full game manual, where they will gain a full-depth comprehension of the VEX IQ Robotics Competition.

As part of the transition, we urge you to have *Students* cross-reference these rules with the full game manual and collate what they know with what they’re learning. If your *Team* has a specific question about a rule in this document, take a look at the full game manual for clarification before posting to the official [VEX IQ Q&A system](#). Related rule numbers from the full game manual are included after each bullet in this appendix (listed as <SG#>, <G#>, etc.) to help you compare.

We hope that you’ll find this guide helpful and that more *Students* feel welcomed, supported, and empowered to join your *Teams*. Have an awesome season!

How Do You Play Rapid Relay?

Main Goals:

- Pass the *Balls* between *Robots*.
- Score *Balls* through *Targets*.
- Clear *Switches*.
- Human *Loaders* bring the *Balls* back and re-add them to the game through the *Loading Station*.

Field Overview

Important Parts of the Field

- **Balls:** There are three *Balls* used in the game.
 - Two *Balls* start with the *Robots*.
 - One *Ball* starts outside the *Field* and can be used by a *Loader*.
 - Only two *Balls* can be on the *Field* at a time.
- **Goal Wall:** This wall has *Targets* and *Switches*.
 - Four *Targets* to score *Balls*.
 - Four *Switches* to be cleared by hitting them with *Balls*.

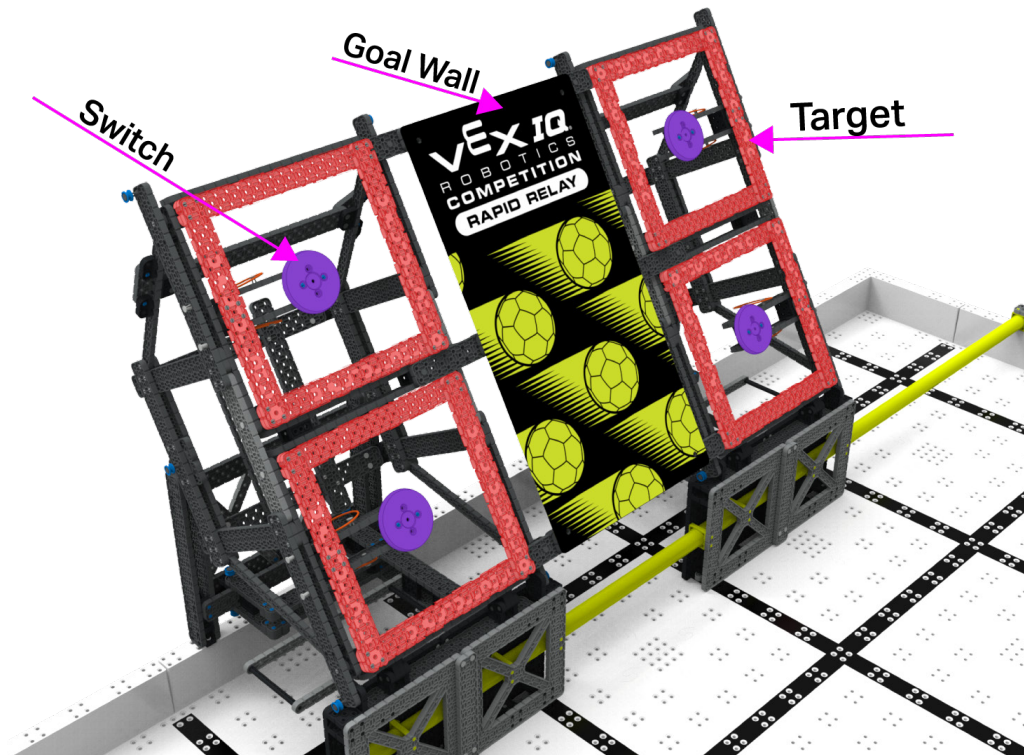

- **Loading Station:** This is where *Balls* start and get *Loaded* into the *Field*.

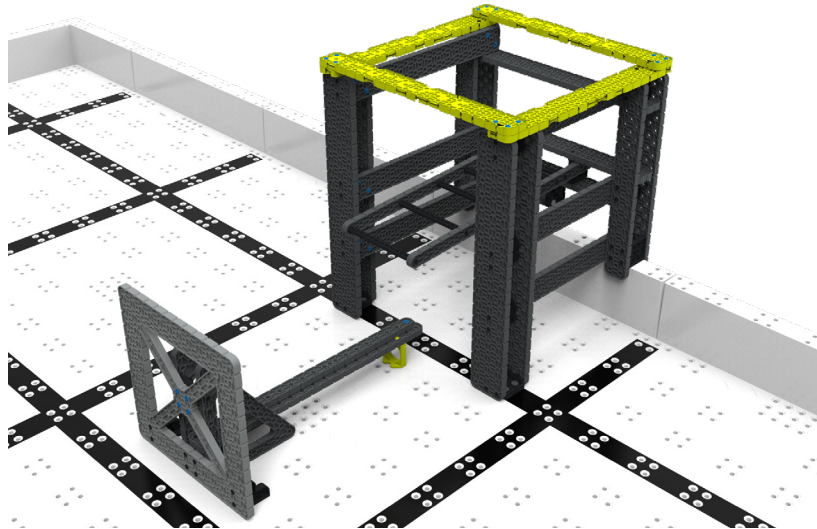

- **Pickup Zone:** This is where *Balls* go after scoring. *Loaders* pick up *Balls* from this zone.
- **Starting Zones:** This is where *Robots* start the game. 1 *Robot* per zone.

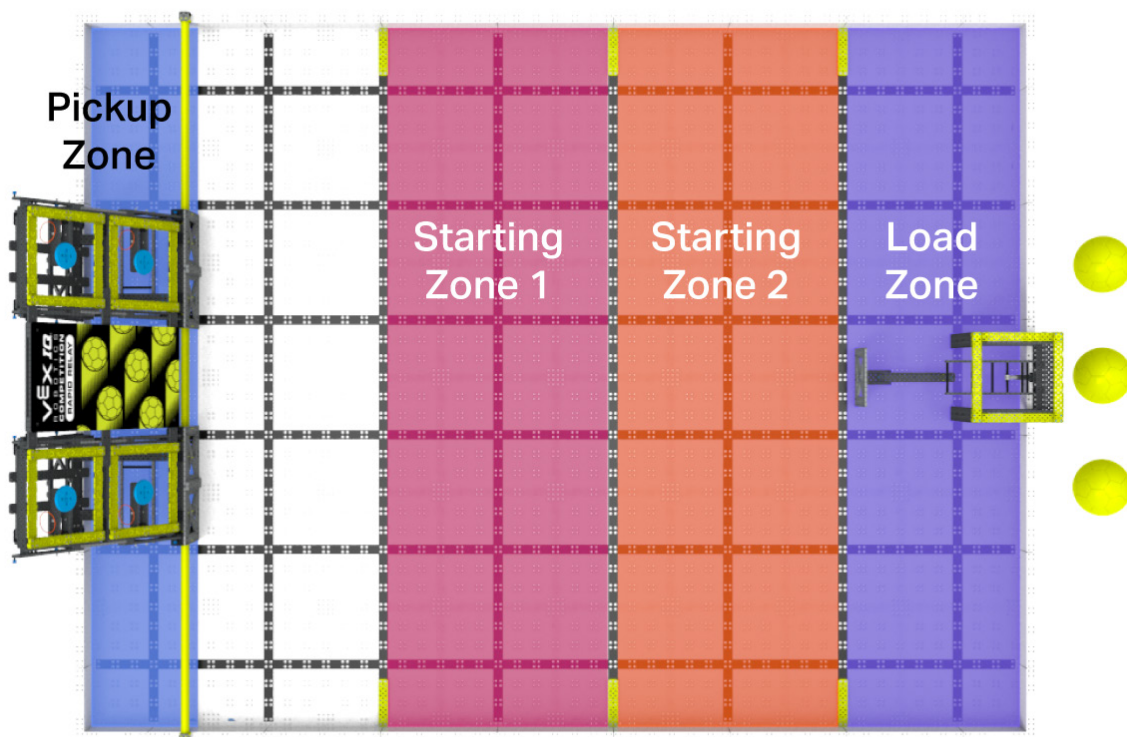

Versions of the Game

Teamwork Challenge

The *Teamwork Challenge* is when two *Robots* work together to earn as many points as possible in a 1 minute (60 second) *Match*.

Robot Skills Challenges

The Robot Skills Challenge is a special part of the competition where one *Robot* tries to score as many points as possible by itself. There are two types of Robot Skills Challenge: Driving Skills and Autonomous Coding Skills.

- **Driving Skills Challenge:** In this challenge, you control the *Robot* using the controller to score points.
- **Autonomous Coding Skills Challenge:** In this challenge, the *Robot* moves and scores points by itself using a program you wrote. You cannot control it with the controller.

How to Earn Points

All points are totaled at the end of the match. <SC1>

Points are different between Teamwork Matches and *Robot Skills Matches*.

1. **Passing Balls:** Move the *Ball* from one *Robot* to another. <SC5>
2. **Scoring Goals:** Get the *Ball* through the *Targets*. <SC3>
3. **Clearing Switches:** Hit the *Switches* with *Balls*. <SC4>

Scoring Summary: <SC1-7> <RSC2>

	Teamwork Challenge	Robot Skills Challenge (Autonomous Coding and Driving Skills)
Each Pass - 1 Switch Cleared	4 Points	No Passing in Robot Skills Challenge
Each Pass - 2 Switches Cleared	8 Points	
Each Pass - 3 Switches Cleared	10 Points	
Each Pass - 4 Switches Cleared	12 Points	
Each Goal - 1 Switch Cleared	1 Point	4 Points
Each Goal - 2 Switches Cleared	1 Point	8 Points
Each Goal - 3 Switches Cleared	1 Point	10 Points
Each Goal - 4 Switches Cleared	1 Point	12 Points
Each Cleared Switch	1 Point	1 Point

Important Scoring Rules

- **Goals:** A *Goal* is Scored when a *Ball* goes through a *Target* and lands in the *Pickup Zone*.
- **Cleared Switch:** A *Switch* is *Cleared* when it is hit by a *Ball* and moves.

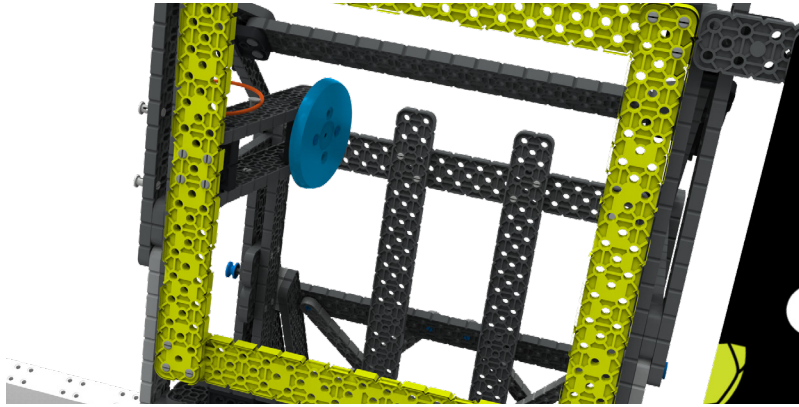

- **Passes:** A *Pass* is counted when both *Robots* touch the *Ball* before it leaves the *Field*.
 - In the *Teamwork Challenge*, a *Ball* can be *Passed* for points only one time per *Goal*. <SC6>

Rules

General Rules

- **Stay Safe:** Always be careful and don't damage the *Field*. <S1> <G7>
- **Be Respectful:** Treat everyone nicely. <G1>
- **Common Sense:** Use your brain and make good choices. <G3>
- **Robot Size:**
 - A *Robot* may never be bigger than 23 inches by 73 inches. <G5> <SG2>
 - A *Robot* may never be taller than 15 inches. <G5><SG2>
- **Keep it Together:** *Robots* should not fall apart or lose pieces during the *Match*. <G6>
- **Driver Rules:** Only *Drivers* can control the *Robot* during the *Match*. <G8>
- **No Hands:** Don't touch the *Field* or *Robots* during the *Match*. <G9>
- **Switch Drivers:** During *Teamwork Matches* and *Driving Skills Matches*, there are two *Drivers* per *Robot*. *Drivers* must switch who is driving the *Robot* when there is between 0:35 and 0:25 seconds remaining in the *Match*. <G11>

Specific Game Rules

- **Setup:** <SG1> <R4>
 - Robots must start the *Match* touching the wall and fully inside of one of the *Starting Zones*.
 - Only one *Robot* per *Starting Zone*.
 - Each *Robot* can start with one *Ball* pre-loaded into their *Robot*.
 - During *Robot Skills Matches* <RSC3>
 - *Robot* must start in *Starting Zone 2*
 - A second *Ball* can be placed anywhere in *Starting Zone 1*

- **Loading Balls:** <SG4>
 - *Balls* are put into the *Field* by the *Loader*
 - Only two *Balls* can be on the *Field* at a time.
 - All *Balls* must be *Loaded* at the *Loading Station* (unless it's a *Rapid Load*).
 - No *Robots* may be in the *Load Zone* at the same time that a *Ball* is released by the *Loader*.
 - The *Loader* may not reach into the *Load Zone* when loading a *Ball*.

- **Pickup Zone:** *Loaders* can pick up *Balls* from the *Pickup Zone*. <SG6>

- **Rapid Load:** *Balls* can be loaded quickly depending on how much time is left in a *Match*. See the table below for times. <SG5>
 - *Rapid Load Balls* must go onto the *Floor* of the *Starting Zone* before being touched by a *Robot*.
 - *Rapid Load Balls* do not get points for *Passes*.
 - The human *Loader* may not touch the *Floor* while placing the *Rapid Load* (example: cannot step into or place a hand on the *Floor* to reach the center of the *Field*).

- **Rapid Load Times:** <SG5> <RSC4>

	Teamwork Challenge Match	Autonomous Coding Skills Match	Driving Skills Match
Rapid Load Start Time	Last 15 seconds of the <i>Match</i>	Entire <i>Match</i> (1 minute)	After <i>Driver</i> Switch
Rapid Load Zones	Both <i>Starting Zones</i>	<i>Starting Zone 2</i> only	<i>Starting Zone 2</i> only